

Electrical Systems - Course 135

UNBALANCED CURRENTS: THEIR EFFECTS

1.0 INTRODUCTION

The previous lesson, 135.01-1 explained that unbalanced currents, caused by faults in three phase systems, produce positive, negative and zero sequence components of current. This lesson explains how these components of current affect rotating and other electrical plant.

2.0 GENERATORS

2.1 Generators: Effects Produced by Positive and Negative Phase Sequence Currents

When a generator is subjected to balanced three-phase loading there will only be positive sequence currents flowing in the generator windings. However, when the generator is subjected to unbalanced loading, positive and negative sequence currents will flow. If a ground fault is present, zero phase sequence currents will also flow. The positive and zero sequence components of current create no problems but any continuous quantity of negative phase sequence current above about 0.08 - 0.15 per unit (depending on the generator in question) will cause severe damage to the rotor in a very short time.

Lesson 135.01-1 showed that a negative sequence current has an RWB phase rotation in the clockwise or negative direction. If a generator is subjected to unbalanced currents, there will be negative sequence (I_2) currents flowing in the stator windings. **These currents will produce negative phase sequence, or reverse rotation, flux in the generator.** The rotor, as it rotates in a positive direction will cut this flux which is rotating in the negative direction. See Figure 1. **Consequently, currents at a frequency of 120 Hz, (in the case of a 60 Hz machine) will be induced into the rotor body.** Due to skin effects, these currents flow on the **surface** of the rotor body and produce a great amount of heat which can irreparably damage a rotor in a very short time.

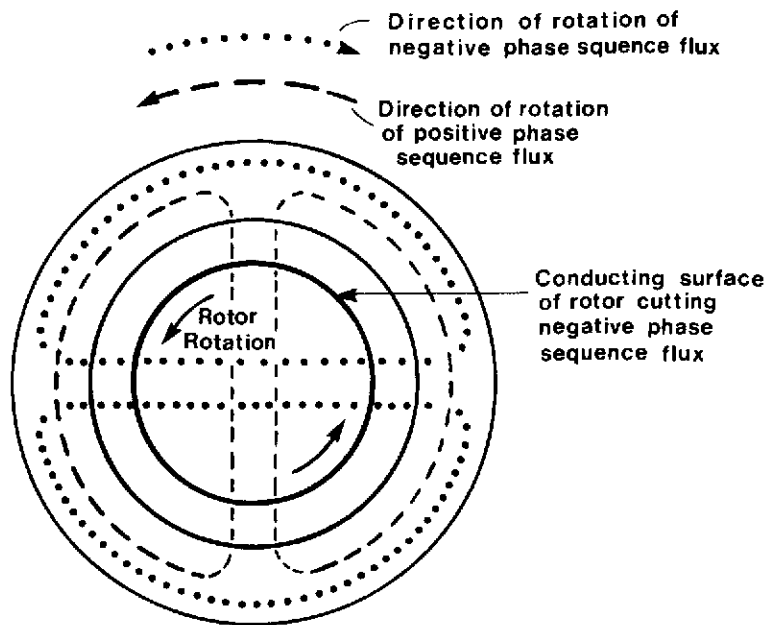

Figure 1: End view of generator rotor and stator showing rotor cutting negative phase sequence fluxes.

It has already been said that a generator can only withstand a 0.08 - 0.15 per unit value of negative phase sequence current **continuously**. When larger values of negative phase sequence currents occur, these currents produce rapid heating by $I_2^2 R$, where I_2 is the per unit value of negative sequence current (compared with full load current). The resistance R is the resistance of the iron in the rotor body and is assumed to be constant. As heat build up is time dependent, then the heating a rotor receives will depend on $I_2^2 R.t$. As R is constant, heating is proportional to $I_2^2 t$. Makers state that their generator rotors will have a certain $I_2^2 t$ rating. For example, Parsons Generators at BNGS 'A' have an $I_2^2 t$ rating of 3.0. If a negative phase sequence current of 0.5 per unit flows in the stator windings, the rotor will be damaged in 12 seconds. The calculation for this time is:

$$\text{Given: } I_2^2 t = 3.0.$$

Substituting 0.5 for I_2 gives

$$(0.5 \times 0.5)t = 3.0$$

$$t = \frac{3}{.25} = 12 \text{ seconds}$$

If the magnitude of I_2 was 2.0 per unit of full load current, the generator would be damaged after 0.75 seconds.

Larger generators have $I_2^2 t$ values of 2.5 - 10 and smaller generators have values up to 30.

Negative phase sequence current heating occurs when a generator is subjected to large magnitudes of negative sequence currents which persist for a long time. This can happen when:

- (a) Line and other faults are not cleared quickly.
- (b) A conductor burns through or breaks leaving only two lines in service giving, for example, only W-B current flowing in the generator. This W-B current is made up of equal quantities of positive and negative sequence components of current.
- (c) Incorrect test procedures where unbalanced currents in the generator are allowed to persist for long periods of time.

It should now be appreciated that generators should be protected against damaging quantities of negative sequence current and this is achieved by using relays and networks which operate when excessive values of $I_2^2 t$ occur. An alarm is provided which operates when the continuous I_2 rating of the generator is exceeded (usually 0.08 to 0.15 pu of full load current for large generators) and a trip occurs when the $I_2^2 t$ rating is exceeded.

2.2 Detection and measurement of negative sequence currents. Figure 2 shows three CT's installed at the neutral of a generator. The output of the CT's is fed into a negative sequence current detection network. The network has two outputs:

- (a) a "low set point" output which feeds a relay which is set to give an alarm when the **continuous** I_2 rating of the generator is exceeded.
- (b) a "high set point" output which is fed into either a disc type or a thermal type relay. The output from this relay is arranged to trip the generator after the $I_2^2 t$ setting has been exceeded.

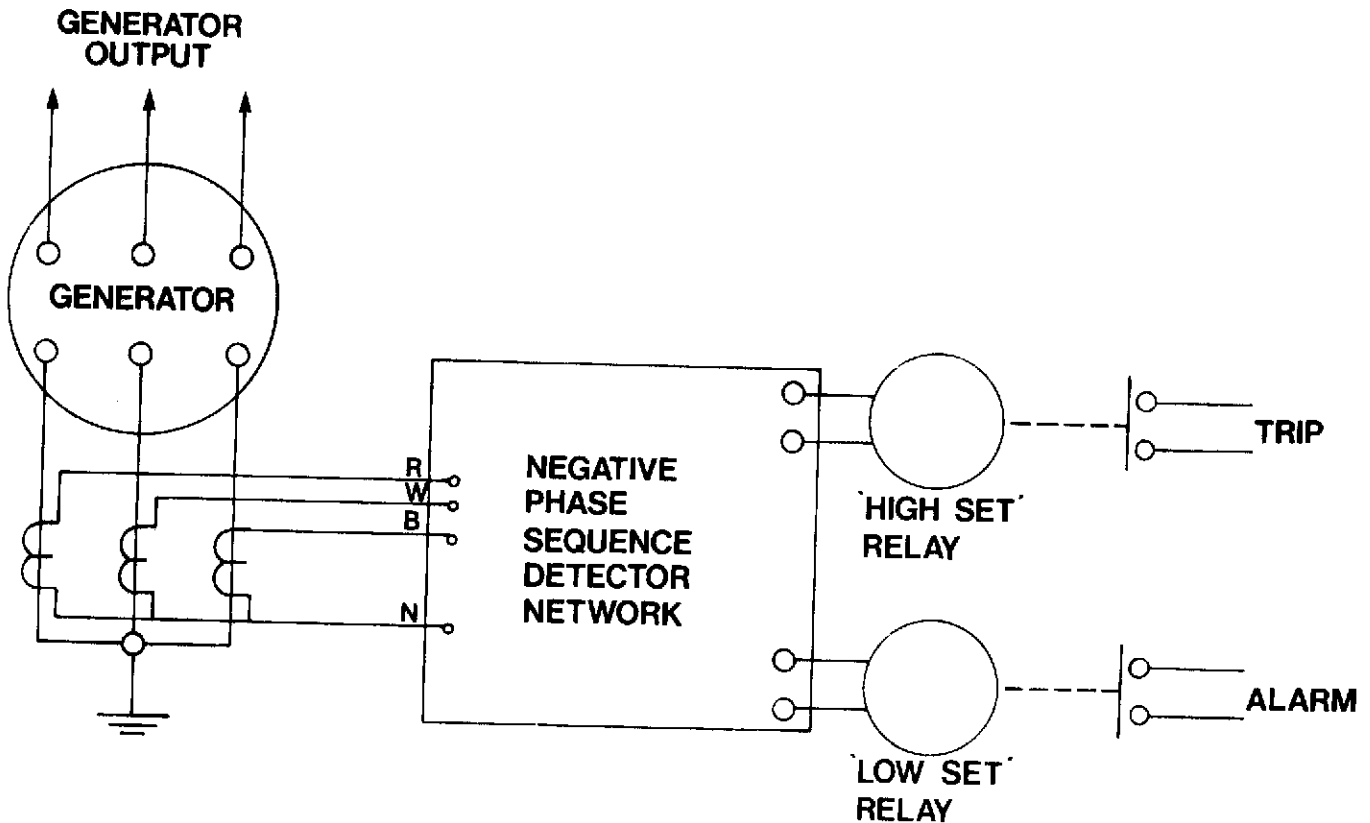

Figure 2: Diagram showing how a negative phase sequence trip and alarm is achieved.

2.3 Effects produced by zero sequence currents.
 The previous lesson has already explained that zero sequence currents only occur when a generator is subjected to ground fault current. The fluxes produced in a generator by zero sequence currents will not take the usual loop paths as shown in Figure 1. Because the currents are all in phase (not displaced by 120°) the fluxes produced by each winding will also be in phase and produce fluxes which flow toward the centre of the generator rotor. Figure 3(a) shows the flux produced by each phase flowing radially inwards. Figure 3(b) shows that the fluxes must form complete loops. Note that these loops pass inwards towards the centre of the rotor and then longitudinally before returning via bearings, hydrogen seals and the iron frame to the source. Because a ground fault is usually cleared within a few cycles, these fluxes usually cause little or no damage - with one exception. This exception is that the shaft can become magnetized **longitudinally** and the residual value of magnetism can be quite large. During subsequent running, eddy currents can be induced by this residual magnetism onto bearings and hydrogen seals. These currents can wreck the delicate surfaces of the bearings and hydrogen seals. The only way of demagnetizing the rotor is to apply a reverse mmf which will provide the necessary demagnetizing force.

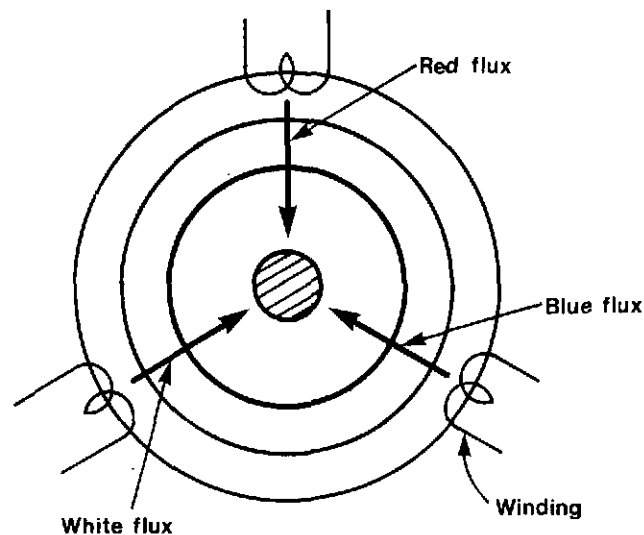

Figure 3(a): Endview of generator showing fluxes produced by zero sequence currents.

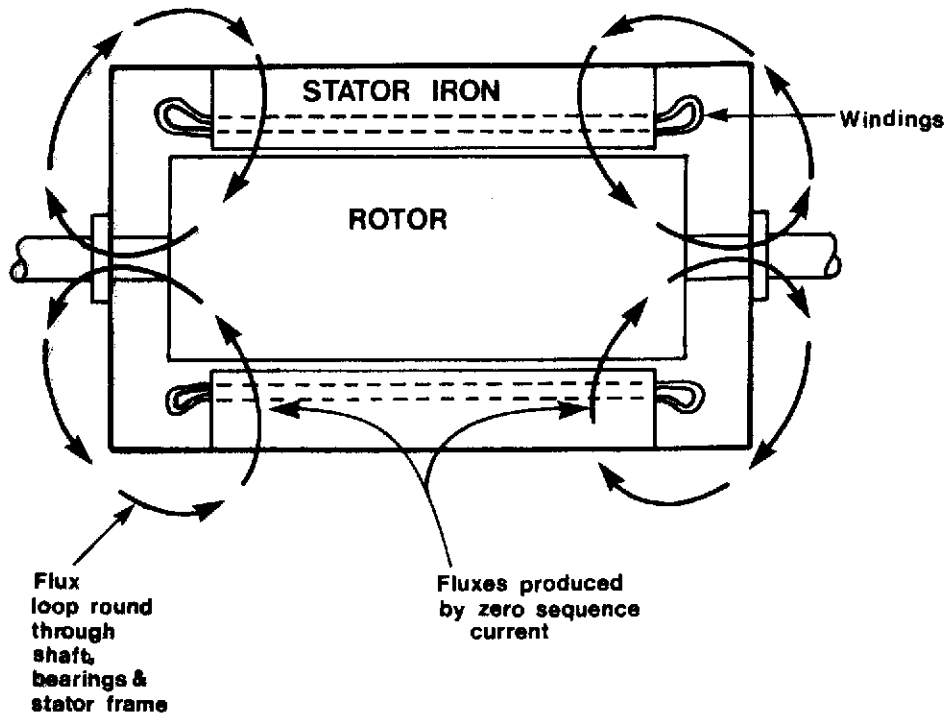

Figure 3(b): Fluxes produced by zero sequence currents.

Smaller generators, combustion turbines etc, are usually directly connected to the system so ground faults on the generator or on the system will cause zero (and positive and negative) sequence currents to flow in the generator. All large generators are connected to the system using step-up transformers having a delta primary (LV) and a star secondary (HV). Ground faults occurring on the secondary side of the transformer, ie, the HV transmission system, will appear as a line-to-line (L-L) fault at the generator. Figure 4 shows how this occurs.

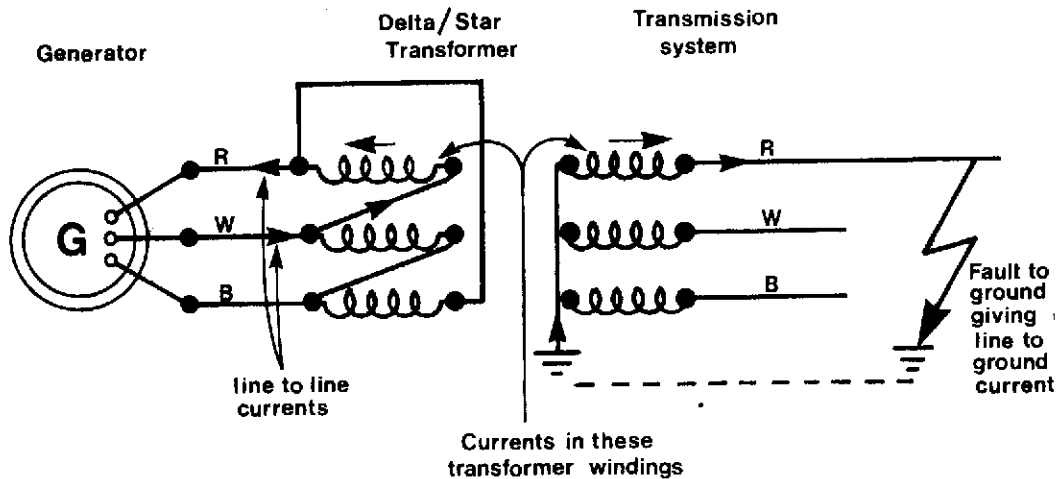

Figure 4: Transmission L-G fault producing L-L currents in generator.

It follows that when a transmission L-G fault occurs, no ground or zero sequence currents flow in the generator. However, it should be appreciated that when a L-G fault occurs on the generator windings, main connections or the transformer primary, ground and zero sequence currents will flow in the generator.

3.0 INDUCTION MOTORS

3.1 Effects produced by positive and negative sequence currents. When a normal 3 phase balanced supply is switched onto an induction motor, a rotating magnetic field is created which causes the motor to start and run. However, unbalances can occur in the supply current due to unbalanced windings or unbalanced supply voltages (for example, different impedances in the supply lines or blown supply fuses).

If the currents to the motor are unbalanced, then due to the negative phase sequence component of current flowing in the stator windings, the motor will be subjected to a rotating magnetic field rotating in the positive or normal direction and a negative rotating field which is rotating in the reverse direction. The reverse rotating magnetic field will:

- (a) apply a reverse torque to the rotor.
- (b) tend to reduce the output torque.
- (c) cause the motor to draw more current from the supply. The reverse RMF will produce a reverse torque. Consequently the motor has to take more current to drive the load.
- (d) induce 120 Hz currents in the rotor (in the case of a 60 Hz motor). These current will cause extra heating in the rotor and can lead to severe damage.

To guard against motor damage, negative phase sequence protection can be applied to induction motors. Because this type of protection is very expensive, the normal phase unbalance protection is usually adequate. P&B Golds relays have a phase unbalance detecting mechanism which is set to trip if the magnitude of the current unbalance is 12% or 20% depending on the built in setting on the relay. The setting is determined by the spacing of the phase unbalance contacts.

3.2 Effects Produced by Zero Sequence Currents

Zero sequence currents, because they are quickly cleared from the system, do not produce any damage or problems in induction motors. If the fault producing zero sequence currents was slow to clear it would have a braking effect on the motor as all the rotor conductors would be cutting this flux.

4.0 TRANSFORMERS

4.1 Because three-phase transformers do not have rotary components, they will operate equally well when supplying positive, negative or a combination of positive and negative sequence currents. If the three-phase transformer consists of three single phase units, the transformer can supply zero sequence currents. The fluxes produced by these currents circulate in the cores producing no problems. See Figure 5.

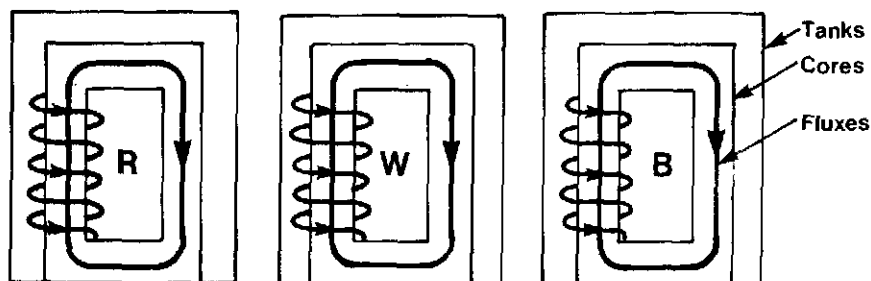

NOTE: Fluxes are all in phase

Figure 5: Fluxes produced in three single phase transformers, by zero sequence currents.

However, if the transformer is a three phase unit, see Figure 6, the fluxes produced by the zero sequence currents all flow in the same direction in the core and consequently there is no return path via the core. The fluxes have to return via the tank walls, clamps etc. Again, because ground faults are cleared quickly, the problems caused in transformers by zero sequence currents, cause no damage. If the fault was allowed to persist, considerable eddy current heating of the tank would occur.

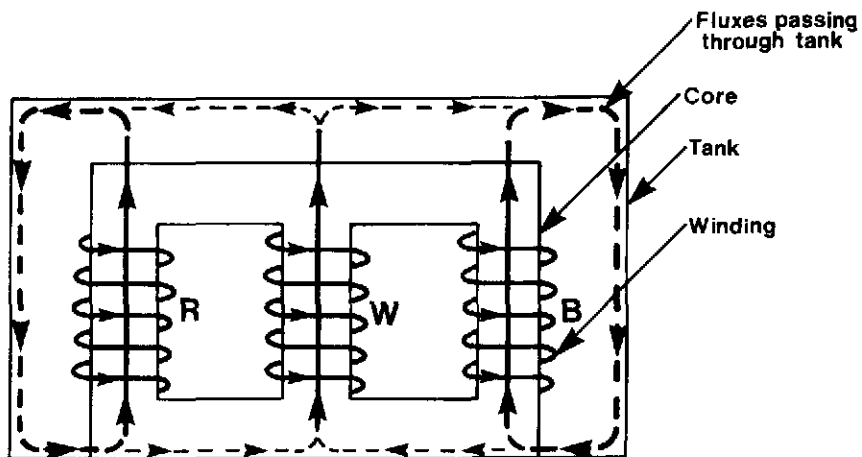

NOTE: fluxes are all in phase

Figure 6: Fluxes produced in a three phase transformer by zero sequence currents.

ASSIGNMENT

1. (a) Explain how 120 Hz currents can be produced in the rotor of a 60 Hz generator.
(b) Explain how these currents can damage a generator rotor.

- 2.. A generator has the following characteristics stated by the manufacturer:
 - (i) I_2 continuous withstand = .12 pu
 - (ii) $I_2^2 t = 4.0$(a) Explain what these figures signify.
(b) If a generator having an $I_2^2 t = 15$ was subjected to a L-G fault at its terminals and the negative phase sequence current was .75 pu, how long could the generator continue to operate before its rotor became damaged?

3. Line to ground faults on the transmission system for large generators produce positive and negative phase sequence currents at the generator terminals. Line to ground faults on the transmission system for small generators produce positive, negative and zero phase sequence currents at the generator terminals. Explain, using a labelled diagram, why this difference occurs.

4. Explain the effects negative and zero phase sequence currents have on:
 - (a) An induction motor.
 - (b) A transformer.

J.R.C. Cowling