

# **KANUPP – IAEA Training**

**Moderator System  
Chemistry Control**

# **Moderator & Auxiliaries** **97146-215**

## **Course Objectives**

- **State the purpose as well as major components of the following:**
  - **Main Moderator System**
  - **Moderator Purification System**
  - **Moderator Cover Gas System**
  - **Moderator Poison Addition System**
  - **Liquid Injection Shutdown System**
  
- **State the primary chemistry objective of chemical control of the main moderator system.**

# Moderator & Auxiliaries

## 97146-215

### Course Objectives

- Describe the process of radiolysis indicating why  $D_2$  ,  $O_2$  and  $D_2O_2$  can result from the radiolysis of  $D_2O$ .
- State and explain six (6) factors which affect the rate of buildup of  $D_2$  and  $O_2$  in the Moderator Cover Gas System and how each is controlled.
- State the desired operating values for the following:
  - Moderator pH
  - Moderator Dissolved  $D_2$
  - Chlorides
  - Fluorides
  - Nitrates
  - Organics

# **Moderator & Auxiliaries**

## **97146-215**

### **Course Objectives**

- **State the factors which will affect the purification half-time in the moderator purification system.**
- **Describe how Boron would be removed or added to the main moderator system. Explain why boron is more difficult to remove from the moderator water as compared to gadolinium.**
- **State when oxygen addition to the moderator cover gas would be necessary.**

# **Moderator & Auxiliaries** **97146-215**

## **Course Objectives**

- **State the moderator cover gas specifications and concerns associated with the following:**
  - **D<sub>2</sub>**
  - **O<sub>2</sub>**
  - **N<sub>2</sub>**
- **State the actions to be taken in the event of a moderator cover gas deuterium excursion. This will include action levels, as well as possible causes and corrective actions to be employed.**

# **Moderator & Auxiliaries** **97146-215**

## **Course Objectives**

- **Define positive and negative reactivity.**
- **Briefly describe the process of xenon simulation. Why is gadolinium nitrate used for xenon simulation instead of boron.**
- **State two (2) problems associated with using gadolinium nitrate as a neutron absorber in the moderator system.**
- **State two (2) problems associated with using boric anhydride as a neutron absorber in the moderator system.**

# **Moderator & Auxiliaries**

## **97146-215**

### **Course Objectives**

- **Define Guaranteed Shutdown. Explain the difference between a GSS1 & GSS2 condition.**
- **Explain the basis for the following chemistry specifications:**
  - **Boron concentration in the Moderator Poison Addition Tank.**
  - **Gadolinium concentration in the Moderator Poison Addition Tank.**
  - **Moderator Gadolinium concentration required for both a GSS1 & GSS2 condition.**
  - **LISS Injection Tank Gadolinium concentration.**

# **Moderator & Auxiliaries** **97146-215**

## **Course Objectives**

- **State the required Chem Tech actions for the following out of specification parameters:**
  - **High or Low pH**
  - **High conductivity**
  - **High nitrates**
  - **High dissolved D<sub>2</sub>**
- **State what radionuclides are to be expected in the main moderator system.**
- **State the effect of moderator D<sub>2</sub>O isotopic on reactor operation (both high and low isotopic).**



# **Moderator & Auxiliaries** **97146-215**

## **Course Objectives**

- **State the main hazards associated with the main moderator system as well as its subsystems.**
- **State the OP & P stipulations associated with the following:**
  - **Main Moderator System**
  - **Moderator Cover Gas**
  - **LISS System**

# Fission of U-235

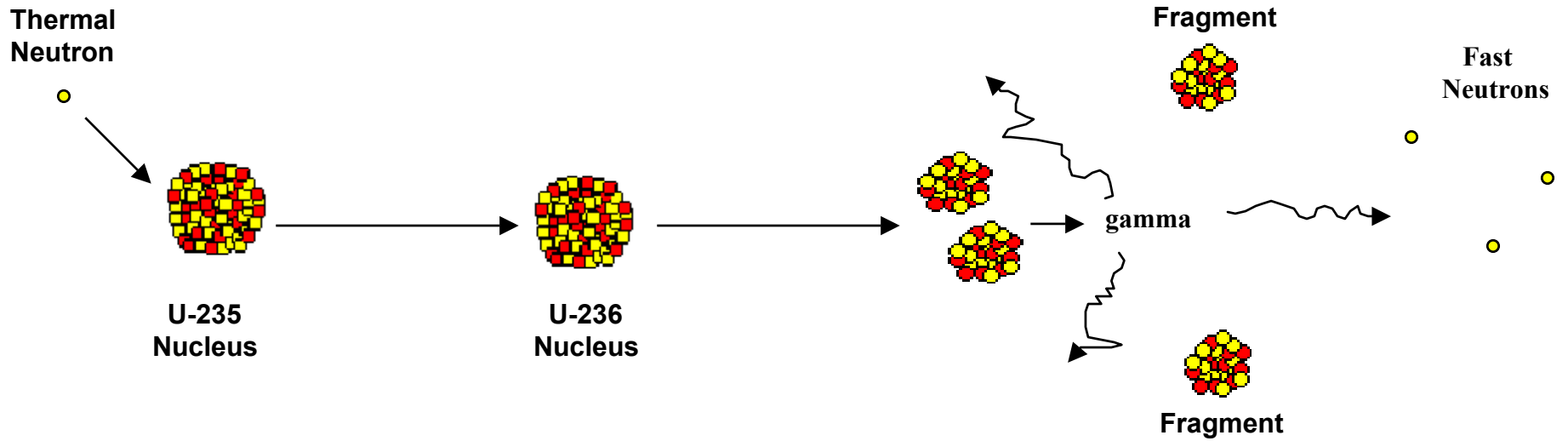

# Main Moderator System

## System Purpose

- **Moderates the high energy fission neutrons in the reactor to the required thermal energy required to promote further fission.**
- **Serves as a medium to add chemicals required for reactivity control.**
- **Provides a heat sink in the event of a LOCA coincident with a loss of or unavailability of ECC.**
- **Removes heat generated by the neutron moderation process.**

# **Main Moderator System**

## **Major Components**

- **Main Moderator Pumps (2)**
- **Heat Exchangers (2)**
- **Calandria Head Tank**
- **System piping**



# Main Moderator System

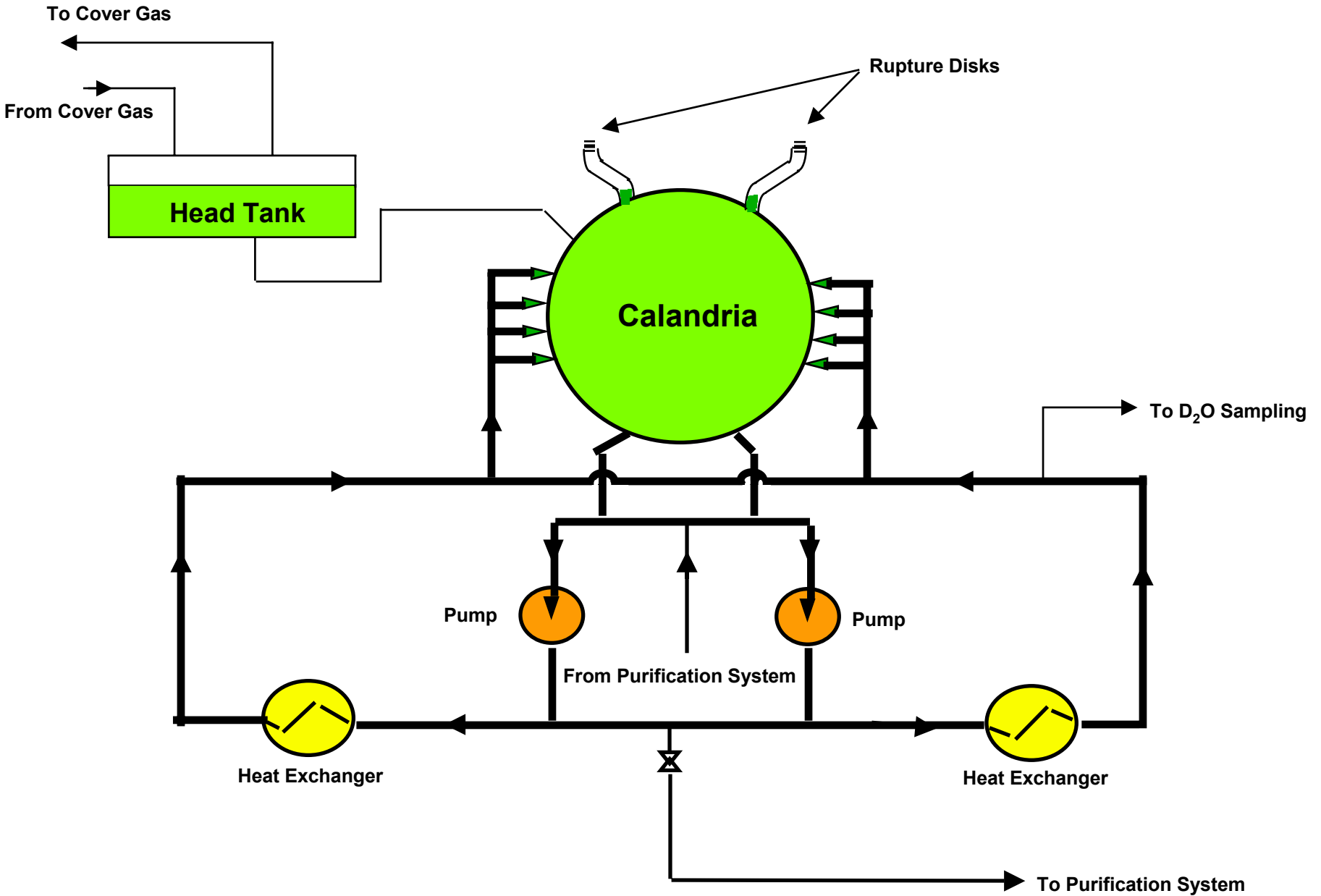

# Main Moderator System

## Main Moderator Pumps

- **Two 100% Capacity Pumps.**
- **Normal operation - one pump 'ON' and the other on 'Standby'.**
- **Each pump provided with two motors**
  - » **a main motor - rated capacity of 940 L/s - used during normal operation**
  - » **a pony motor - rated capacity of 235 L/s (drives pump at 25% of rated speed) - used to remove decay heat during reactor shutdown.**
- **Pump components made of stainless steel.**

# Main Moderator System

## Heat Exchangers

- **Two (2) Heat Exchangers in service at all times**
  - » Each heat exchanger designed to remove 50% of moderator heat load - 120 MW thermal heat (60 MW per heat exchanger).
- **Heat Exchangers cool the moderator water from 71°C down to 43°C.**
- **U tube-in shell design. RCW used for cooling.**
- **RCW supply on heat exchanger shell side lower than the D<sub>2</sub>O on the tube side in order to minimize the possibility of D<sub>2</sub>O downgrading.**
- **Construction**
  - » Tube side - Sandvick 3RE-60 (low carbon alloy of Fe, Cr and Mo).
  - » Shell side - Carbon Steel.



# Main Moderator System

## Moderator Cooling

- **Minimize thermal stresses in the calandria.**
- **Prevent boiling within the calandria.**
- **Reactivity Control**
- **Minimize dissolved D<sub>2</sub> release from the water and thus minimize the possibility of a cover gas D<sub>2</sub> excursion.**
- **Low moderator temperature will improve its performance as a heat sink in the event of a LOCA coincident with an unavailability or a loss of ECC.**

*If Moderator Temperature exceeds 80°C (on two out of three measurements), a reactor power setback will occur - 1% F.P./sec to a final value of 2% full power.*

## Main Moderator System

### Calandria Head Tank

- **Maintains D<sub>2</sub>O level in the calandria. Accommodates D<sub>2</sub>O volume fluctuations in the calandria caused by temperature changes.**
- **Limits the D<sub>2</sub>O volume in the calandria to 0.61 m above the top of the calandria (into the relief ducts). This limitation is based on the capacity of the head tank.**
- **Helium cover gas space maintained above the water in the tank.**
- **Construction**
  - » **304/304L Stainless Steel.**

# **MAIN MODERATOR SYSTEM**

## **Chemistry Objectives**

- **To control the radiolytic decomposition of  $D_2O$  to limit the concentration of deuterium and oxygen in the cover gas to below explosive concentrations.**
- **Minimize corrosion of system components.**
- **Maintain soluble neutron poisons at specified concentrations for reactivity control purposes.**



# MAIN MODERATOR SYSTEM

## Corrosion Concerns

- **pH:** pH maintained neutral. No pH agents added to the moderator. Too low a pH will increase system corrosion. Too high a pH will result in Gd precipitation.
- **Chlorides:** *Promotes stress corrosion cracking of stainless steel.. Promotes cover gas excursions.*
- **Fluoride:** *Promotes stress corrosion cracking of stainless steel. Also promotes corrosion of Zirconium alloys. Promotes cover gas excursions.*
- **Dissolved D<sub>2</sub>:** *Dissolved D<sub>2</sub> promotes cover gas excursions.*
- **Nitrates:** *High concentration can promote cover gas excursions.*
- **Organics:** *Promotes cover gas excursions.*

# Moderator System

## Standard Operating Conditions

PARAMETER	DESIRED CONDITION	CONTROLLED BY
Conductivity	ALARA ( $\leq 0.1$ mS/m)*	IX resins.
pH	Neutral	IX resins; only in conjunction with conductivity.
pH - in guaranteed shutdown state	4-6	See later section, startup and shutdown.
Cl <sup>-</sup>	ALARA	IX resins.
F <sup>-</sup>	ALARA	No Teflon. Upgraders.
Organics	ALARA	Screens prevent release of IX beads.
Dissolved Deuterium	ALARA	Keep moderator purity high.
Nitrates	ALARA	IX resins. Keep air out.
Cover Gas D <sub>2</sub>	ALARA (< 2%)* Alarm level is $\geq 2\%$	Recombiners. Purging.
Cover Gas O <sub>2</sub>	Min: $\frac{1}{2}$ D <sub>2</sub> concentration Max: 3%	Manual addition. Recombiners.
Cover Gas N <sub>2</sub>	ALARA ( $\leq 2\%$ )	Prevent ingress. Purging.
Poison Addition Tank pH	= 4	Replacement of solution if pH is incorrect.
Poison Injection Tank pH	= 3	
* Numerical values in brackets are NGD Divisional Chemical Specifications.		

Overhead 70

AEUB Conventional Nuclear General

## KANUPP Moderator System Chemistry Specification

• pH	=	< 6.0
• Conductivity	=	< 1 umho/cm
• Chloride	=	< 0.1 ppm
• Carbonate	=	ND
• Copper	=	ND
• Iron	=	ND
• Peroxide	=	< 0.1 ppm
• Boron	=	As required
• Ammonia	=	ND
• Isotopic	=	> 99.63% D20

# MAIN MODERATOR SYSTEM

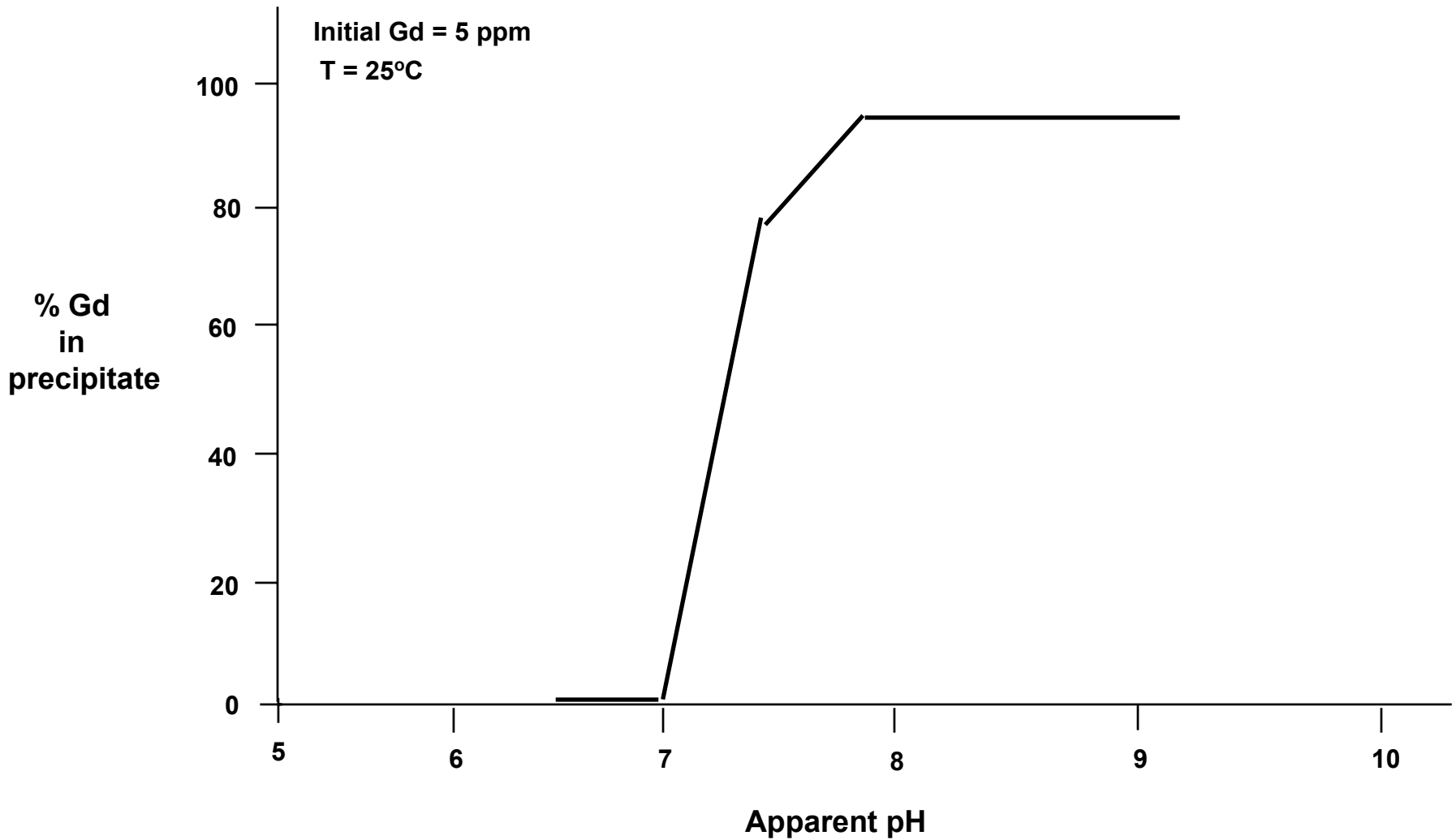



# **Main Moderator System**

## **Main Moderator Subsystems**

- **Moderator Purification System**
- **Cover Gas System**
- **Liquid Poison System**
- **D<sub>2</sub>O Sampling System**
- **D<sub>2</sub>O Collection & Supply System**
- **D<sub>2</sub>O Vapour Recovery System**

# Moderator Purification

## System Purpose

- **Maintains the purity of the moderator D<sub>2</sub>O to minimize radiolysis, thus preventing excessive production of D<sub>2</sub>, and to minimize corrosion of components.**
- **Removes the soluble poisons, boron and gadolinium - depending upon reactivity demands.**
- **Removes gadolinium after initiation of the liquid injection shutdown system.**

# Moderator Purification

## Major Components

- **Purification Cooler**
- **Filter**
- **Strainer**
- **Ion Exchange Vessels (5)**

## **Moderator Purification**

### **Purification Cooler**

- **maintains outlet temperature at 43°C. Temperature must be maintained below 60°C to prevent resin breakdown.**
- **Tube material is Sandvik Alloy 3RE60 (resistant to chloride induced stress corrosion cracking).**
- **Shell composed of carbon steel. RCW used for cooling.**

## Moderator Purification

### Filter

- **Removes insoluble matter from the incoming flow before it passes through the IX columns.**
- **Nominal filter rating - 5  $\mu\text{M}$ .**

### Strainer

- **Purpose is to prevent ion exchange resin from entering the main moderator system.**
- **Located on the common outlet line from the discharge of the IX columns.**
- **Strainer size - 0.25 mm (+60 mesh). Resin size is 0.38 - 60 mm.**

## **Moderator Purification**

### **Ion Exchange Columns**

- **Five Vessels.**
- **Each vessel contains 200 liters of IRN-150 resin. Vessel capacity is 255 liters (allows for resin swelling).**
- **Each vessel contains an inlet & outlet screen - 0.2 mm size.**
- **Ion exchange vessels constructed of 304L Stainless Steel.**

# Moderator Purification

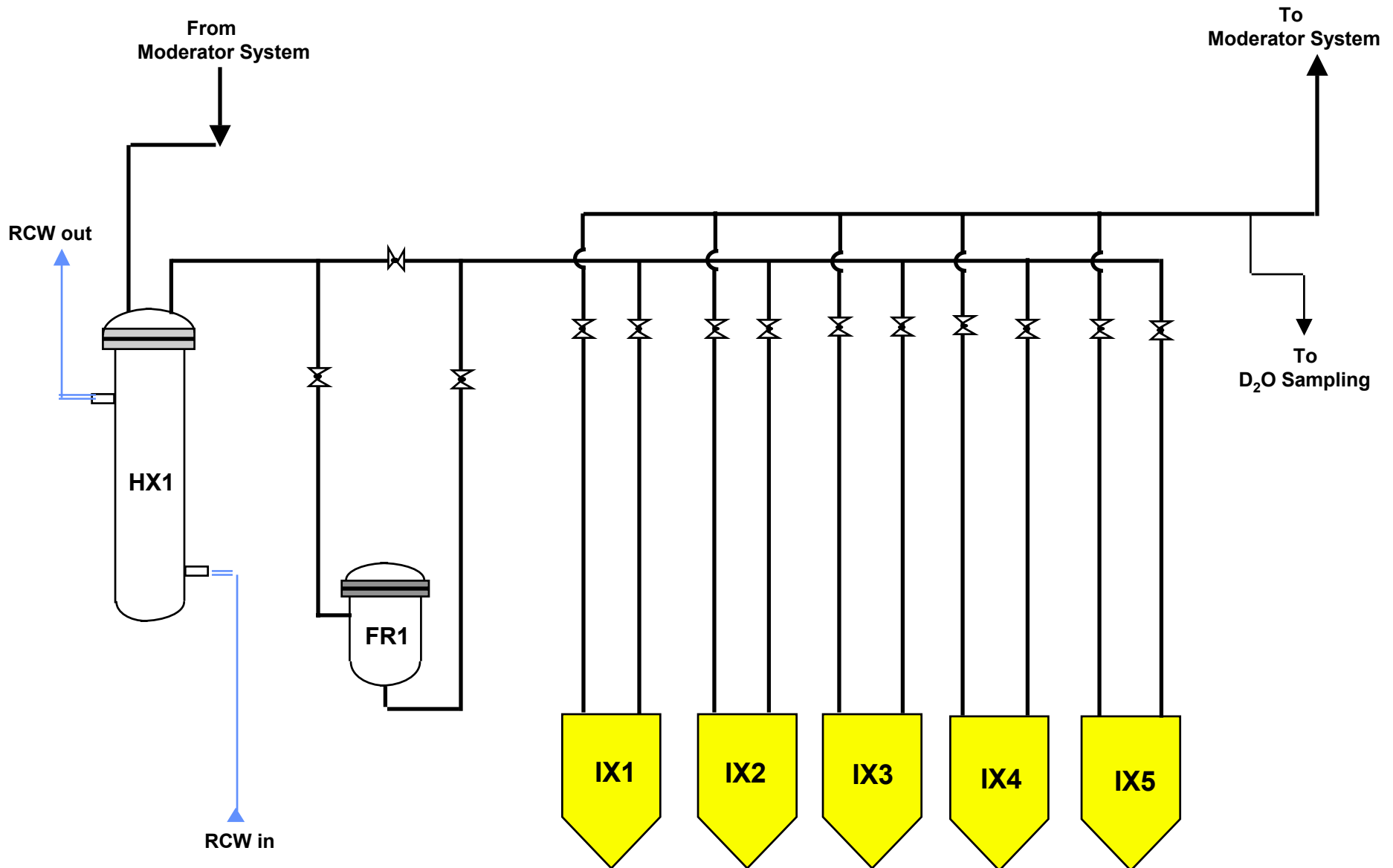

# Moderator Purification

## Purification Half-Time

- **By-pass purification systems, in which the main flow is bypassed for purification and then re-injected into the main flow have an effect on impurities that is expressed as follows:**

$$C = C_0 \times e^{\frac{-Ft}{M}}$$

where **C** = concentration at time t

**C<sub>0</sub>** = initial concentration when purification is begun

**F** = purification flow rate

**M** = mass of system to purified

**t** = time purification is used

**e** = has a value of 2.718 (irrational number)



# Moderator Purification

Moderator Purification Half Time as a function of Purification Flow Rate

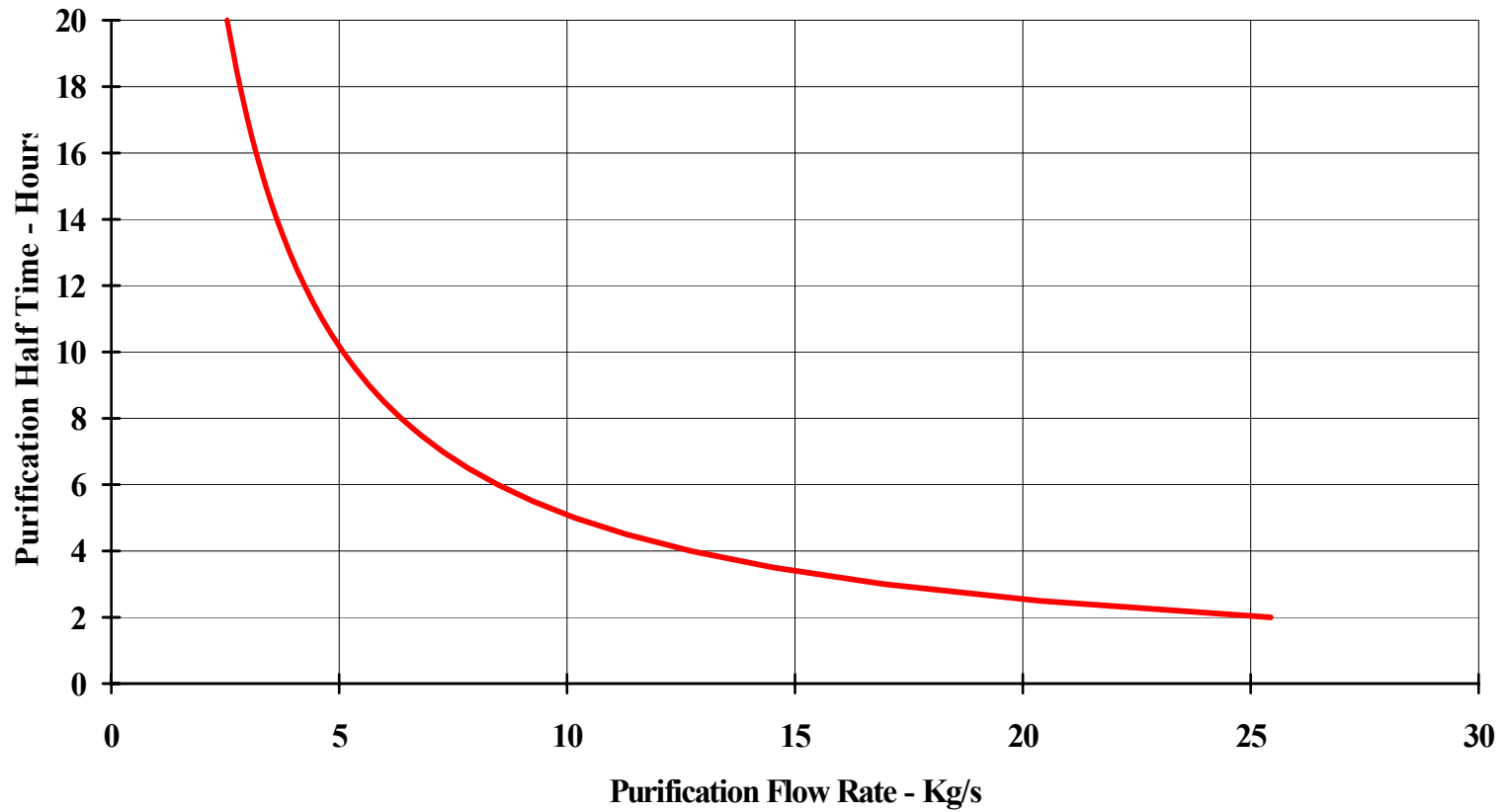

# Moderator Purification

## GSS Removal - Time to reach 1.61 mg/Kg

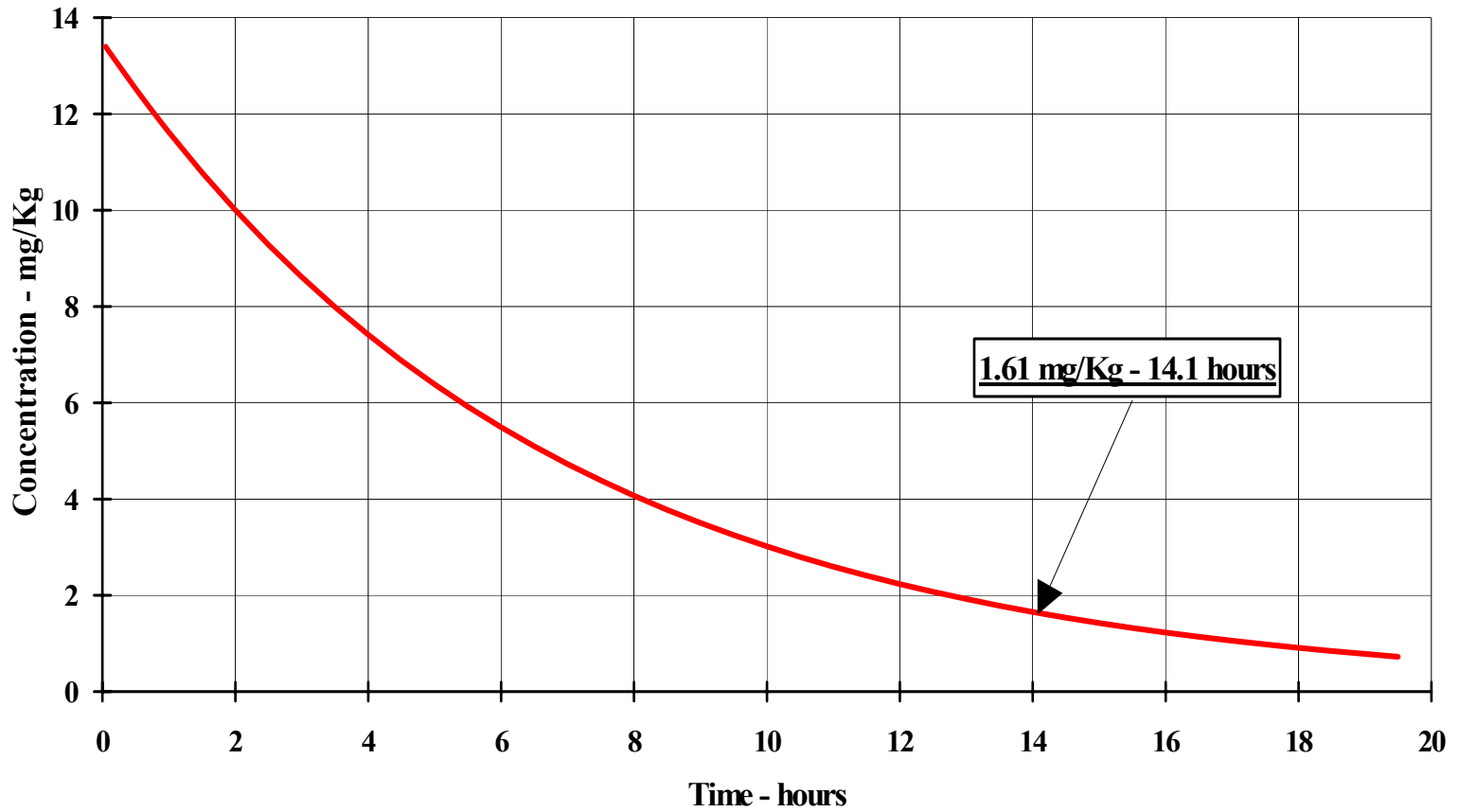

*Based on a purification flow rate of 11.0 Kg/sec*

# Moderator Purification

## Time to reach 1.61 mg/Kg after a LISS Injection

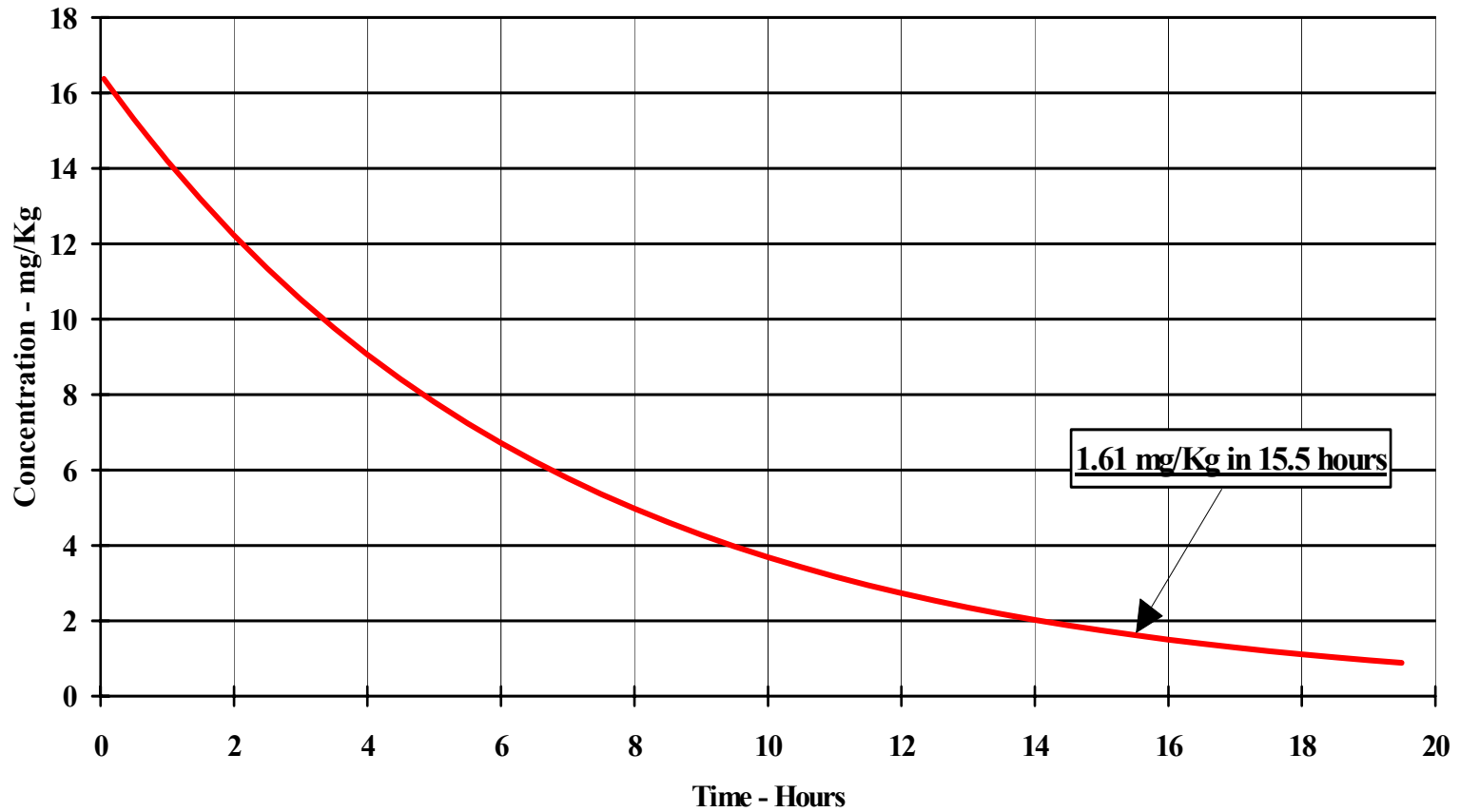

*Based on a purification flow rate of 11.0 Kg/sec*

# Moderator Purification

## Resin Capacity

- **One fresh column (200 liters of resin) has a capacity for two LISS injections.**
  - » A Liss injection will result in a moderator Gd concentration of about 16.5 mg/Kg.
- **Resin has a limited capacity for Boron removal. Capacity will depend upon the boron concentration fed to the resin.**
  - » Resins saturate quickly on boron. Boron concentration on the resin must be less than the boron concentration of the feed in order to remove boron.
  - » If boron on the resin is at a higher concentration than the feed, boron will be eluted from the resin.
  - » Boron is removed or added to the moderator by taking advantage of the above two characteristics.

# Moderator Purification

Boron Capacity of IRN-150 Resin as a function of Boron Feed Concentration

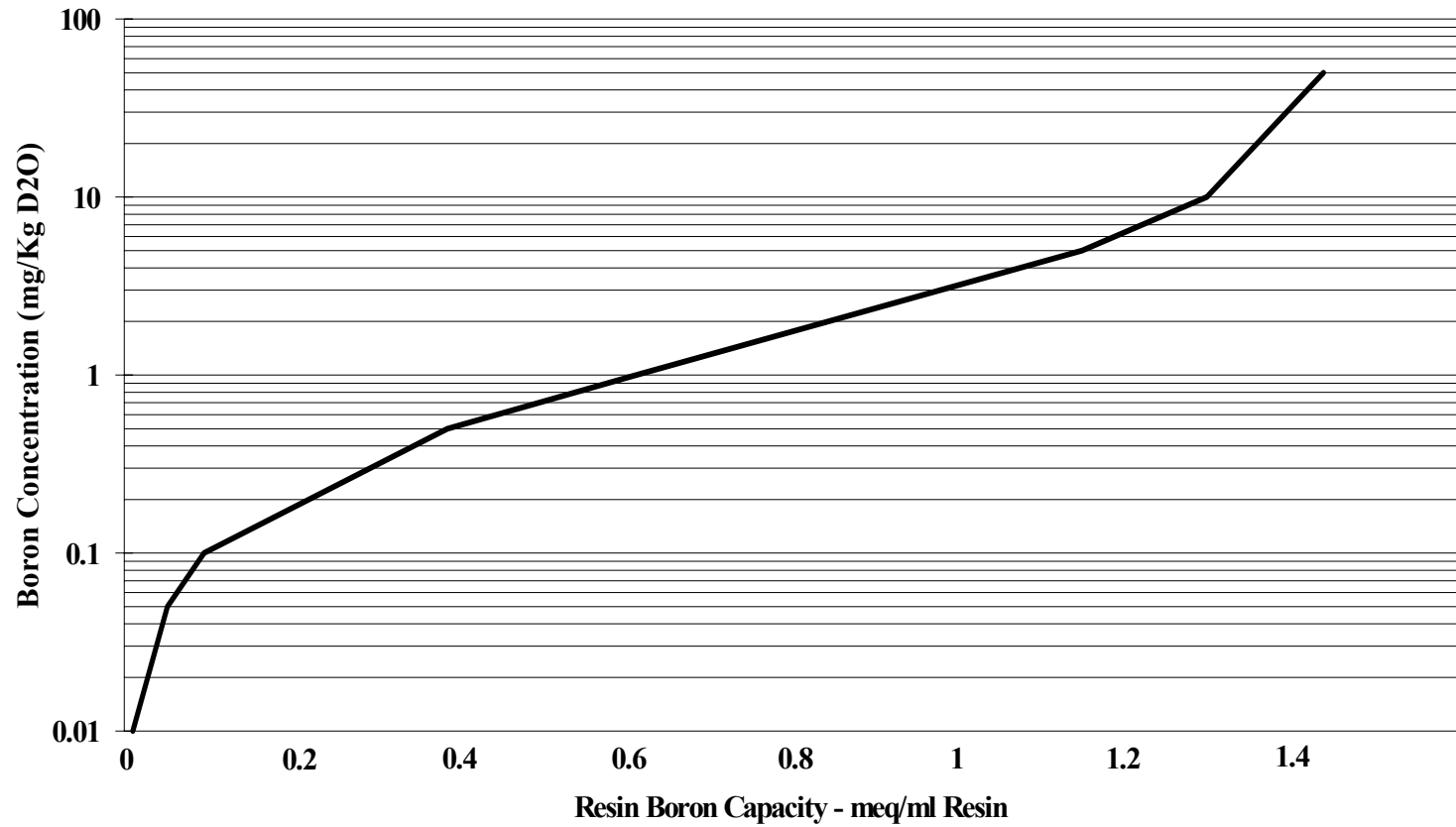

# Moderator Cover Gas

## System Functions

- Provides an inert gas cover for the moderator.
- Circulates the gas to prevent significant concentrations of  $D_2$  in the cover gas.
- Controls the amount of  $D_2$  in the cover gas by recombining it with  $O_2$  to form heavy water.
- Maintains the cover gas pressure above the minimum compatible with the equilibrium amount of  $D_2$  dissolved in the moderator.
- Provides helium make-up to maintain cover gas pressure and for purging.

## Moderator Cover Gas

### Major Components

- **Compressors (2)**
- **Flame Arrestors (2)**
- **Preheaters (2)**
- **Recombination Units (2)**
- **Direct Contact Cooler**
- **Helium Makeup**

# Moderator Cover Gas System

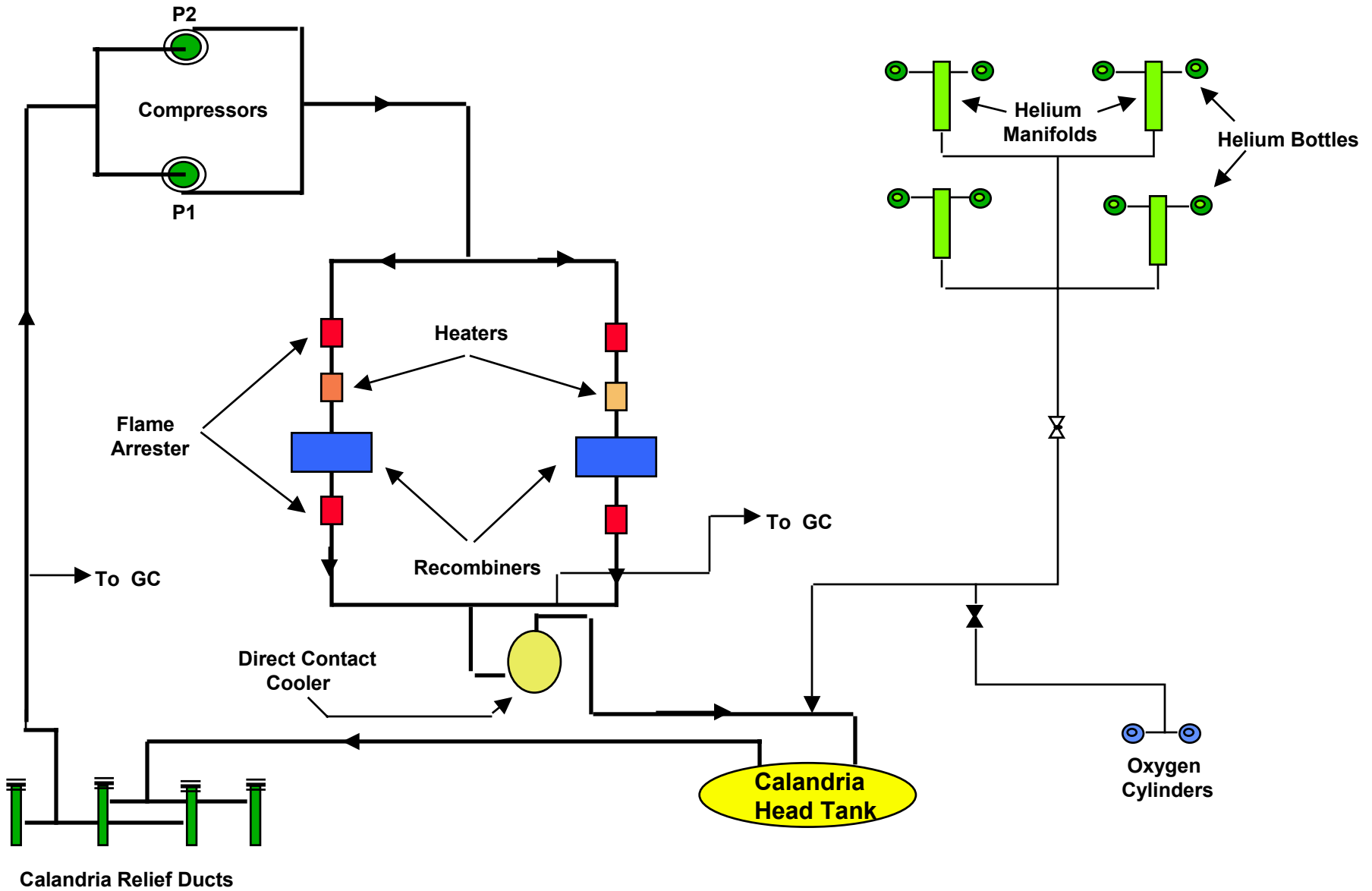



# Moderator Cover Gas

## Compressors

- **Two 100% Compressors**
  - » Normal configuration is one compressor ON and the other compressor on STDBY. The second compressor will come ON automatically when the cover gas %D<sub>2</sub> reaches 2% (as indicated by the on-line G.C.).
- **The gas compression diaphragm is separated from the compressor fluid by a spacer. This will prevent oil from entering the cover gas in the event of a diaphragm failure.**
- **Compressor Flow Rate - 4.7 L/s (for one compressor).**

## Moderator Cover Gas

### Preheaters

- **Two electric strip type preheaters.**
- **Heats up the gas prior to entry into the recombiners - improves recombination efficiency. Also ensures that the gas is dry prior to entry into the R.U. units as the catalyst will become poisoned when wet.**

## Moderator Cover Gas

### Recombination Units

- **Two Recombination Units.**
  - » **Stainless Steel all welded design - unit welded into the process piping**
  - » **Palladium catalyst - 0.2% palladium on alumina**
- **Catalyst poisoned by water - water removed from the gas by the preheaters.**

## Moderator Cover Gas

### Direct Contact Cooler

- Cools the hot gases/vapours prior to entry back into the moderator.
- A tank through hot gas rises, contacts cool D<sub>2</sub>O which flows downward through a packing.
- D<sub>2</sub>O for cooling comes from the discharge of the moderator HX's. D<sub>2</sub>O also goes through a Delay Tank (90 sec. delay) to allow for N-16 decay. Two booster pumps supply D<sub>2</sub>O to the Direct Contact Cooler during shutdowns.
- Cools the gas to 71°C - assuming 4% D<sub>2</sub> at the R.U. inlet and complete recombination has occurred.

## Moderator Cover Gas

### Flame Arrestors

- **Four Flame Arrestors - one upstream and one downstream of each of the two recombiners.**
- **Prevents flame propagation in the cover gas circuit should explosive recombination of  $D_2$  and  $O_2$  occur.**
- **The flame arrestors consist of stacks of stainless steel washers. These stacked washers prevent the propagation of a flame (works in the same way as wire mesh e.g., safety cans).**

## Moderator Cover Gas

### Helium Makeup

- **The use of helium reduces corrosion in the calandria, minimizes formation of nitric acid in the calandria by purging out any ingressing air, and reduces the formation of Ar-41 in the system.**
- **99.99% Helium used.**
  - » cylinders arranged in four manifolds of eight cylinders.
  - » Normal operation - only 8 helium cylinders in use. At least 16 of the remaining 24 cylinders should be full to ensure adequate helium for system purging.
- **Provision is made for connection of an oxygen cylinder to the gas header to provide oxygen addition as required for recombination with the D<sub>2</sub> in the cover gas.**

# Moderator Cover Gas

## System Data

Cover Gas Volume - Normal operation (71°C)	7.65 m <sup>3</sup>
Cover Gas Volume - Shutdown (21°)	12 m <sup>3</sup>
T <sub>1/2</sub> for D <sub>2</sub> with one compressor I/S	19 minutes
Normal system pressure	21 Kpa (g)

## Chemistry Specifications

D <sub>2</sub>	4.0%
O <sub>2</sub>	2.0%
N <sub>2</sub>	2.0%

# Moderator Cover Gas

## Cover Gas Concerns

- **Control concentrations of Deuterium - Oxygen - Nitrogen.**
- **Keep the Deuterium concentration as low as possible and the deuterium/oxygen ratio outside the flammable limit.**
  - » Deuterium formation is minimized by maintaining moderator water purity.
  - » Removed by recombination in the R.U. units and by purging if necessary.
- **Maintain low Nitrogen concentrations. Nitrogen can produce nitrogen oxides which will react with the water forming nitric acid. Nitric acid enhances D<sub>2</sub> formation by radiolysis and can increase corrosion rate of system components.**
  - » Controlled by purging the cover gas.
- **High Oxygen levels can increase system corrosion - high oxygen levels in the moderator water. High O<sub>2</sub> concentrations in the cover gas.**
  - » Controlled by purging the cover gas and also by recombination in the R.U. units.



# Gas Flows and Gas Recirculation Including Gas Transfer

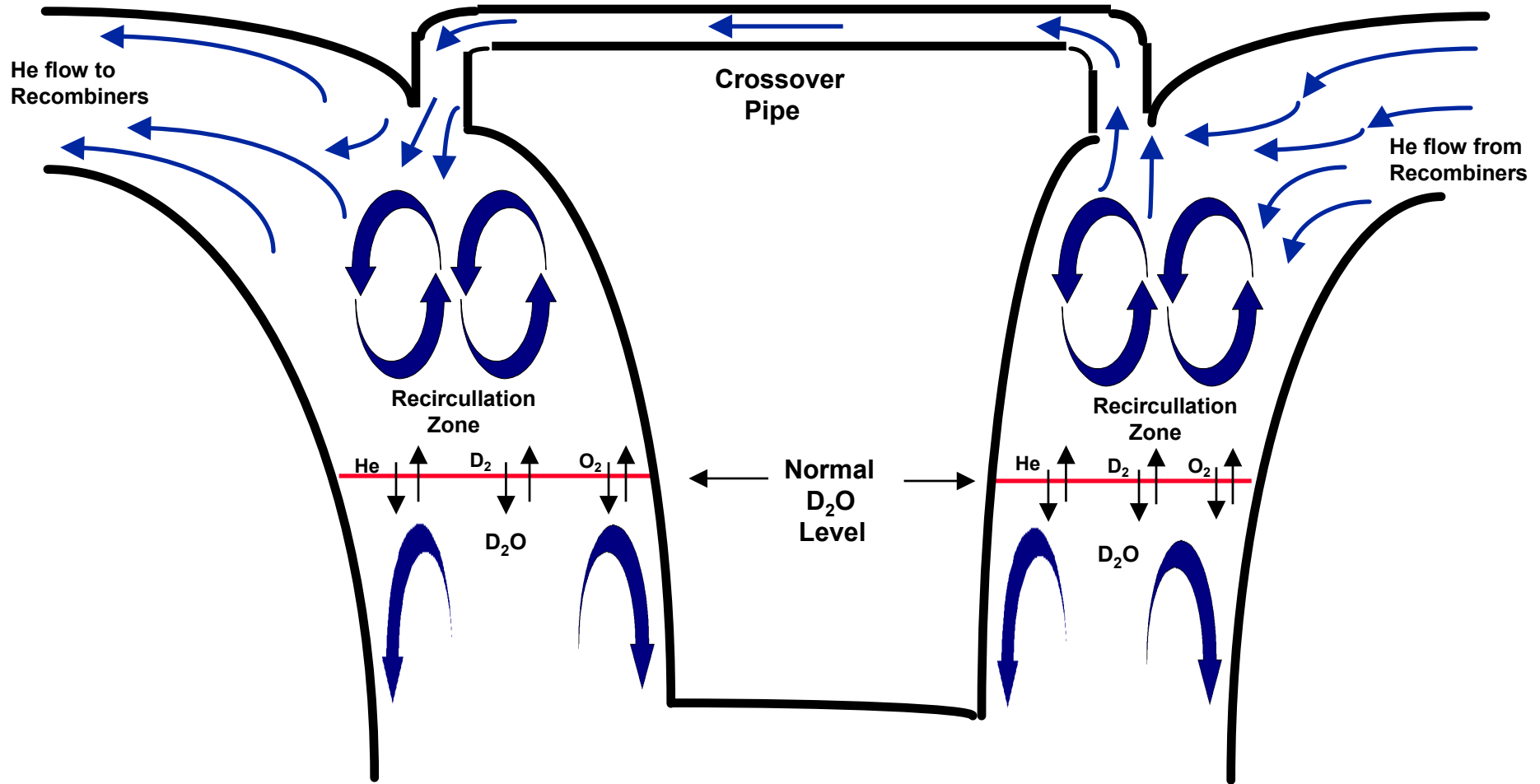

## **Cover Gas Excursions** **Possible Causes**

- **Increase in Reactor Power**
- **Increase in Moderator Temperature**
- ***Decrease in Moderator Level***
- **Decrease in Moderator Cover Gas Pressure**
- ***Increase in Impurity Concentration***
- ***Start-up after a Poison Outage***
- **Poisoning of Recombiner Catalyst**
- **Insufficient Oxygen present to Recombine with the available Deuterium**

# MODERATOR COVER GAS D<sub>2</sub> Excursion

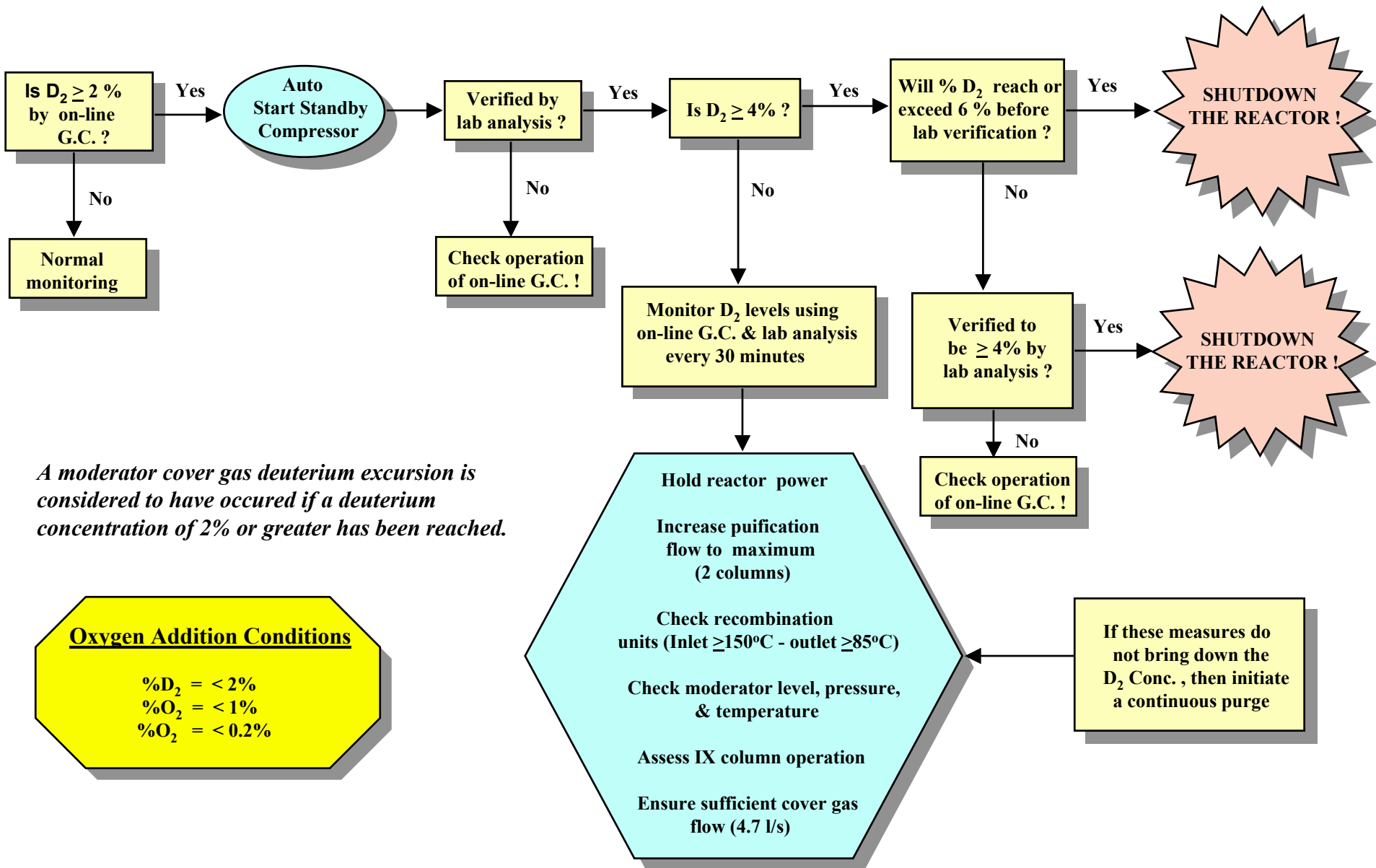

*A moderator cover gas deuterium excursion is considered to have occurred if a deuterium concentration of 2% or greater has been reached.*

## Oxygen Addition Conditions

%D<sub>2</sub> = < 2%  
%O<sub>2</sub> = < 1%  
%O<sub>2</sub> = < 0.2%

# Moderator Liquid Poison System

## System Purpose

- **Adds negative reactivity to the moderator to allow for the excess reactivity of new fuel (poison shim).**
- **Adds negative reactivity to the moderator to allow for the loss of negative reactivity due to decay of xenon after a poison out or long shutdown.**
- **Provides a means of decreasing reactivity in conjunction with other reactivity control devices.**
- **Provides a means to guarantee enough poison in the moderator to prevent critically during shutdown**

# Moderator Liquid Poison System

## Major components

- **Poison Storage Tanks (2)**
  - » 425 Liter Boron Tank - 406 L working vol.
  - » 425 Liter Gadolinium Tank - 406 L working vol.
  - » Tanks constructed of stainless steel
  - » Both tanks provided with agitators
- **Delay Tank**
  - » 36.8 Liter stainless steel tank
  - » permits decay of O-19 & N-16
  - » Total decay about 140 seconds (tank & piping)
- **Sampling pumps & syringe sampling stations**
  - » allows for recirculation of the tank contents as well as tank sampling.

# Moderator Poison Addition

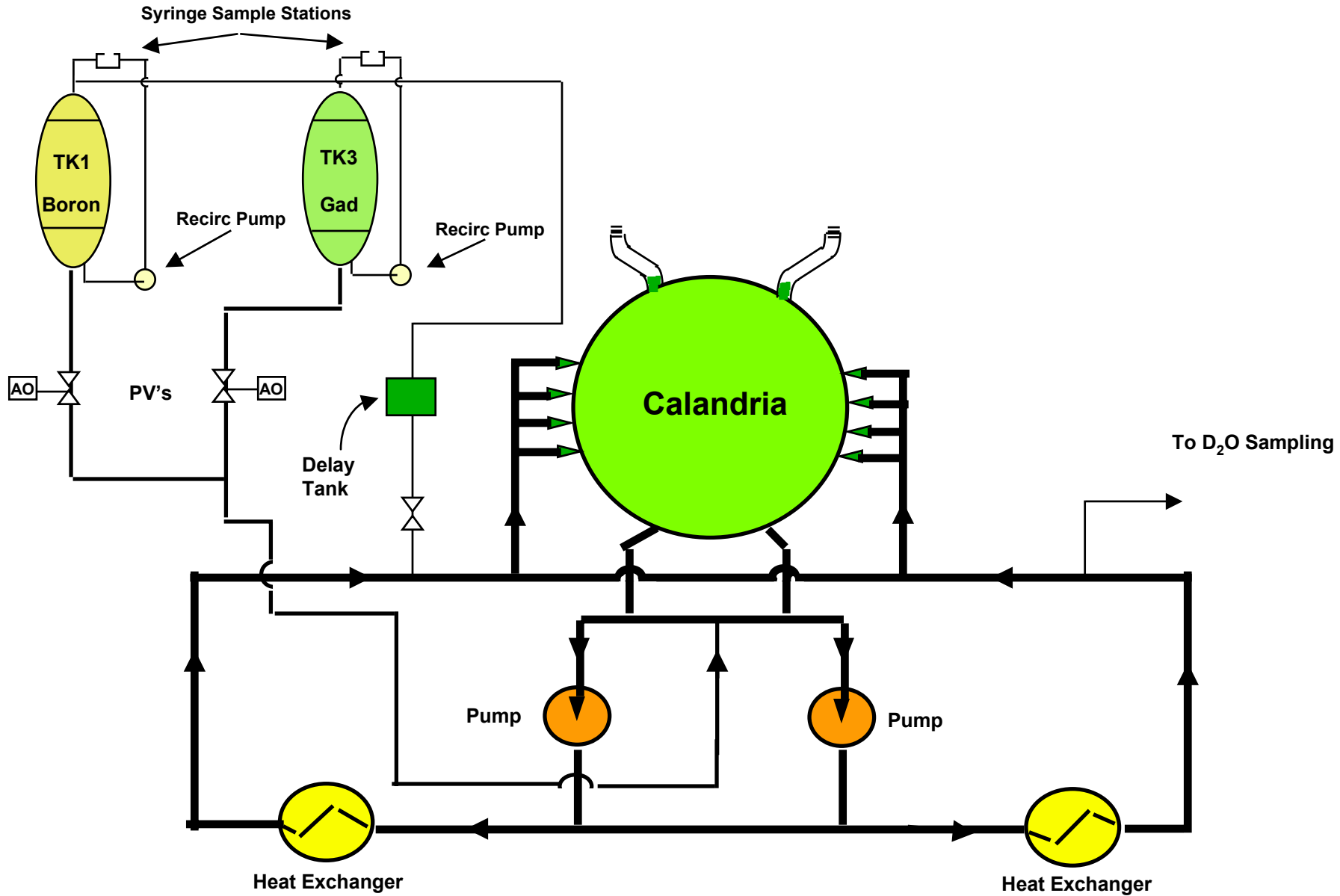

## Moderator Liquid Poison System

Milli K                       $\frac{\text{\# Neutrons Second Generation}}{\text{\# Neutrons first Generation}}$

Milli K = 1.0                      Critical

Milli K = <1.0                      Subcritical

Milli K = > 1.0                      Excess reactivity

1.001 = 1 mK

Xenon in the fuel accounts for - 28 mK (negative reactivity)

## Moderator Liquid Poison System

- **Gadolinium Tank Concentration**      **1200 - 1400 ppm**
  - » **Based on 2.5 xenon simulations**
  
- **Boron Tank Concentration**                      **2700 - 3300 ppm**
  - » **Based on 1.5 xenon simulations**



# Moderator Liquid Poison System

## Gadolinium

- **High neutron cross-section**
  - » **49000 barns (natural)**    **1 barn =  $10^{-24}$  cm<sup>2</sup>**
  - » **Gd-155 (14.73%)**        **61000 barns**
  - » **Gd-157 (15.68%)**        **150000 barns**
- **Low concentrations needed for reactor shutdown**
  
- **1.0 mg/Kg = -31.4 mK**
  - » **0.89 required for xenon simulation**
  
- **Rapid burnout - burns out at about the same rate as xenon builds up in the core.**
  
- **Highly soluble - easily removed by IX resin**

## Moderator Liquid Poison System

### Gadolinium Disadvantages

- **Solubility of  $\text{Gd}(\text{NO}_3)_3 \cdot 6 \text{H}_2\text{O}$  influenced by pH. Precipitates from solution at  $\text{pH} > 6.9$  (apparent  $\text{pH} = 7.36$ ).**
- **The nitrate ion of the salt will result in increased dissolved  $\text{D}_2$  in the moderator water (radiolysis) which in turn will increase the  $\% \text{D}_2$  in the cover gas.**

# Moderator Liquid Poison System

## Boron

- **Used for long term reactivity control - slow burnup rate**
- **Low neutron cross-section**
  - » **760 barns (natural)**
  - » **B-10 (20%)      3800 barns**
  - » **B-11 (80%)      0.005 barns**
- **1 mg/kg = -8.85 mK**
- **Little effect on cover gas D<sub>2</sub> production rates**

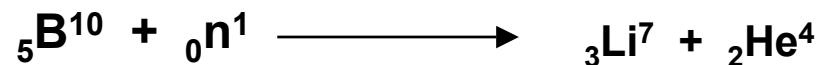

# Moderator Liquid Poison System

## Boron disadvantages

- **Low solubility** (9.5g B/Kg @ 25°C)
  - » not suitable for LISS/SDS2 (32 g B/Kg required)
- **Difficult to dissolve**
- **Weak electrolyte**
  - » difficult to remove by IX resin

# Guaranteed Shutdown

- **Maximum reactivity achievable in the CANDU 600 core is about +120 mK**
- **In order to shut the reactor down, this +120 mK must be compensated for, i.e., equivalent negative reactivity added.**
- **In order to guarantee shutdown, the required amount of negative reactivity is factored up by 1.5 (X 1.5). This number then becomes the required amount of negative reactivity needed to guarantee reactor shutdown.**
  - » **The 1.5 multiplication factor takes into account errors that may be present in calculations, simulations, measurements, etc involving reactivity worths.**
- **Two GSS conditions exist**
  - » **GSS1                      HTS Depressurized**
  - » **GSS2                      HTS Pressurized**

# Guaranteed Shutdown

## Guaranteed Shutdown States

- **GSS1      HTS Depressurized**
  - » Compensation made for possible positive reactivity achievable in the core.

Example:

+120 mK possible

1 ppm Gd = -31.4 mK

$$\frac{+120 \text{ mK}}{-31.4 \text{ mK/ppm Gd}} = 3.82 \text{ ppm Gd required}$$

3.82 x 1.5 (uncertainty factor) = 5.7 ppm Gd required to guarantee shutdown

**6 ppm Gd required for GSS1**

# Guaranteed Shutdown

## Guaranteed Shutdown States

- **GSS1      HTS Depressurized**

### Amount of Boron Required

Example:

+120 mK possible

1 ppm Boron = -8.85 mK

$$\frac{+120 \text{ mK}}{-8.85 \text{ mK/ppm Boron}} = 13.6 \text{ ppm Boron required}$$

13.6 x 1.5 (uncertainty factor) = 20.4 ppm Boron required to guarantee shutdown

**20.4 ppm Boron required for GSS1**

# Guaranteed Shutdown

## Guaranteed Shutdown States

- **GSS2      HTS Pressurized**
  - » In GSS2, the HTS system is pressurized. In this condition, there is a possibility that the HTS system could enter the moderator system and dilute the poison concentration in the moderator water. In order for this to occur, both a calandria & pressure tube rupture would have to occur.
  - » To ensure GSS in the event of an in-core LOCA, the dilution effect of the HTS system entering the moderator must be taken into account.

$$\text{Dilution Effect} = \frac{V_{\text{Moderator}}}{V_{\text{Moderator}} - V_{\text{HTS}}} = \frac{260 \text{ Mg}}{260 \text{ Mg} - 130 \text{ Mg}}$$

**Factor = 2.0**



# Guaranteed Shutdown

## Guaranteed Shutdown States

- **GSS2      HTS Pressurized**

Example:

+120 mK possible

1 ppm Gd = -31.4 mK

$$\frac{+120 \text{ mK}}{-31.4 \text{ mK/ppm Gd}} = 3.82 \text{ ppm Gd required}$$

$$3.82 \times 1.5 \text{ (uncertainty factor)} = 5.7 \text{ ppm Gd required for GSS1}$$

This amount must then be doubled (dilution factor - HTS diluting the moderator system)

$$5.7 \text{ ppm} \times 2.0 = 11.4 \text{ ppm Gd}$$

**11.4 ppm Gd required for GSS2**

# Liquid Injection Shutdown System

## System Purpose

- The purpose of the LISS system is to quickly stop reactor operation by quickly injecting a high concentration gadolinium nitrate solution into the moderator via six horizontal nozzels passing through the calandria.

# Liquid Injection Shutdown System

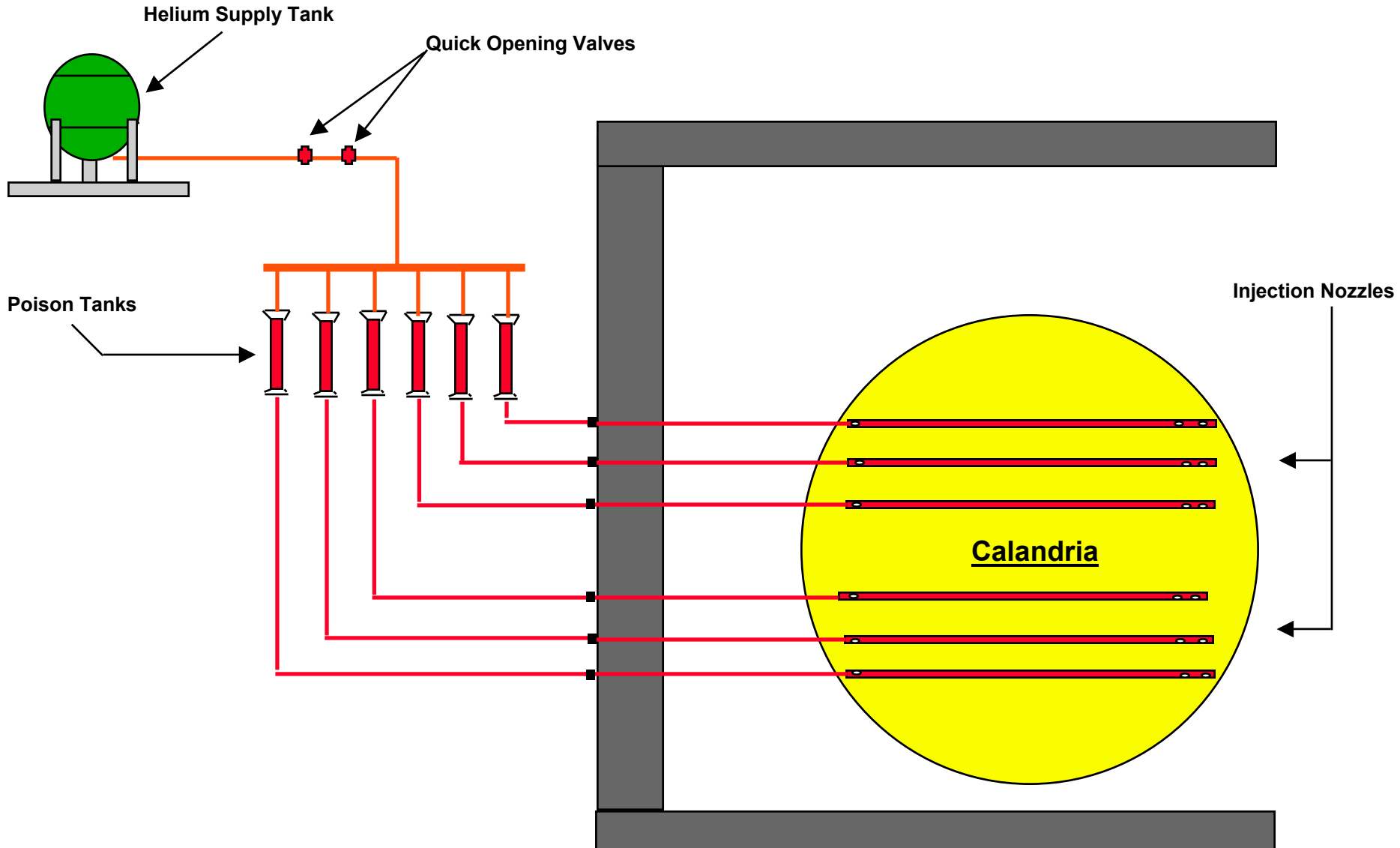

# Liquid Injection Shutdown System

## Major Components

- **Helium Supply Tank**
  - » **Contains 1.1 m<sup>3</sup> of helium at a pressure of 8.4 MPa. This high pressure helium is used to force the gadolinium nitrate solution contained in the injection tanks into the moderator.**
  
- **Poison Injection Tanks (6)**
  - » **6 stainless steel tanks located outside the reactor vault wall. Each tank contains a solution of >8000 ppm (typically about 9500 ppm) gadolinium nitrate solution. Tanks are 0.079 m<sup>3</sup> in size.**
  - » **Floating in the top of each tank is a solid polyethylene ball. When the system is fired, helium from the helium supply tank forces this ball to the bottom of each tank - injecting the poison into the moderator. The ball, seating against the bottom of the tank, prevents helium from over-pressurizing the calandria.**
  
- **Injection Nozzels (6)**
  - » **Holes are drilled in each nozzel along its length to form four rows of jets which inject the poison upward, downward, and to the sides.**
  - » **6 zircolly nozzels which penetrate the calandria horizontally and at right angles to the fuel channel tubes.**

# Liquid Injection Shutdown System

## Major Components

- **Gadolinium Mixing Tank**
  - » **A 0.85 m<sup>3</sup> tank. Large enough to accept the contents of all six tanks as well as the six injection lines.**
  - » **Used to prepare the gadolinium nitrate solution. Each tank has an addition port as well as a mechanical mixer.**
- **Drain Tank**
  - » **A 0.14 m<sup>3</sup> tank. Large enough to hold the contents of one injection tank plus its injection line.**

# Liquid Injection Shutdown System

## System Operation

- **The system must be poised at all times unless the following two conditions exist:**
  - » **The reactor is in a GSS state**
  - » **during an approved calandria filling - the LISS system can only be poised if the moderator level is above a minimum specified level - otherwise injection would be into an empty moderator.**
- **The tanks must contain a solution of gadolinium nitrate at a concentration of not less than 8,000 mg/Kg (Gd).**
- **At least five (5) tanks must be available.**
- **Other operational concerns must be in place, i.e., helium supply, helium supply tank pressure, injection valves in the proper state.**

# **Liquid Injection Shutdown System**

## **System Firing**

**Neutron Overpower**

**Neutron Rate High**

**High/Low Heat Transport Pressure**

**Reactor Building High Pressure**

**Low Pressurizer Level**

**Low Steam Generator Level**

**Boiler Feed Low Pressure**

# Liquid Injection Shutdown System

## Operational Considerations

- Over a period of time the interface between the gadolinium solution and the moderator  $D_2O$  will migrate along the injection lines. Annunciation of this situation is provided by an in-line conductivity probe. The alarm setpoint for this conductivity monitor is 50 mS/m. When annunciation is received, the tank and line is backwashed from the moderator. The tank must then be sampled and Gd concentration adjusted if necessary.
- Injection of The LISS system will result in loss of unit production for at least 36 hours due to poison out of the reactor (xenon).