

M1 Figure 1

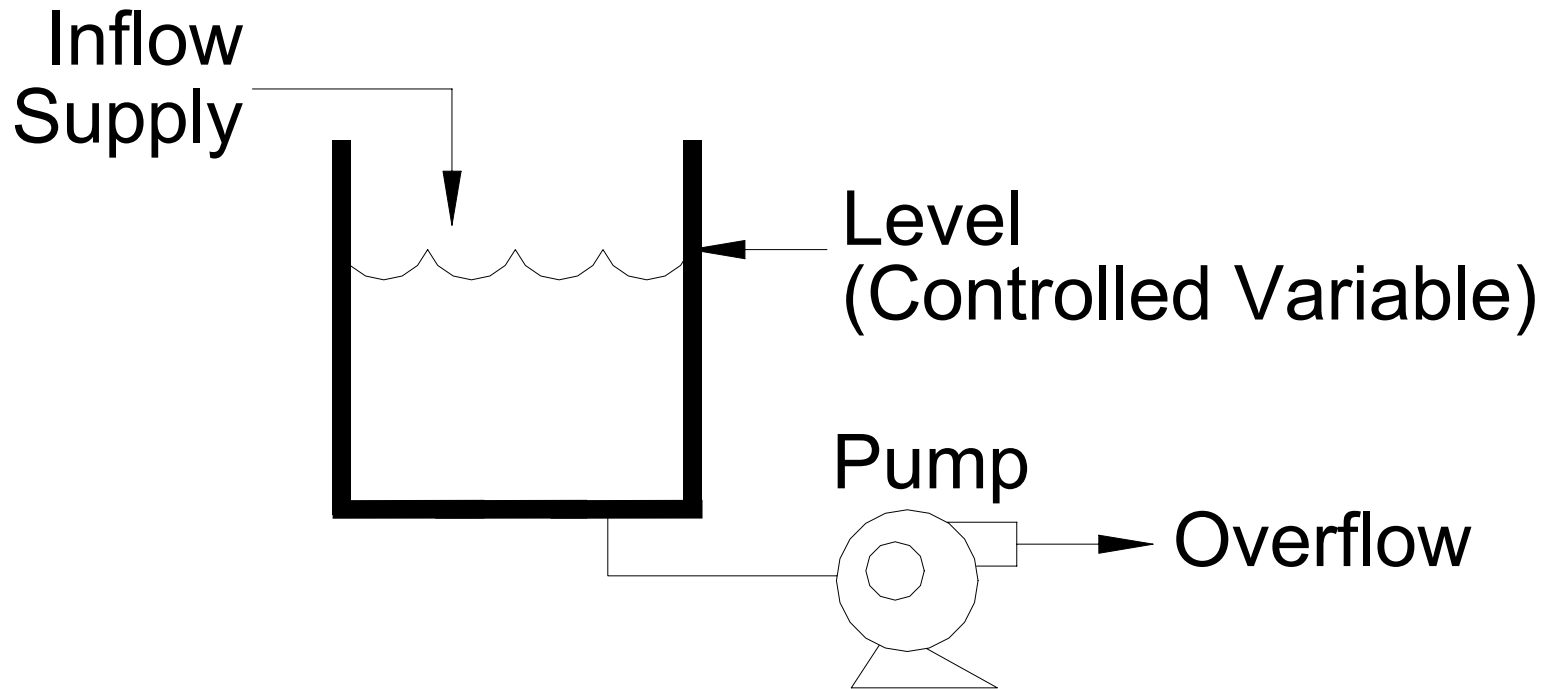

M1 Figure 2: Typical Control Loop

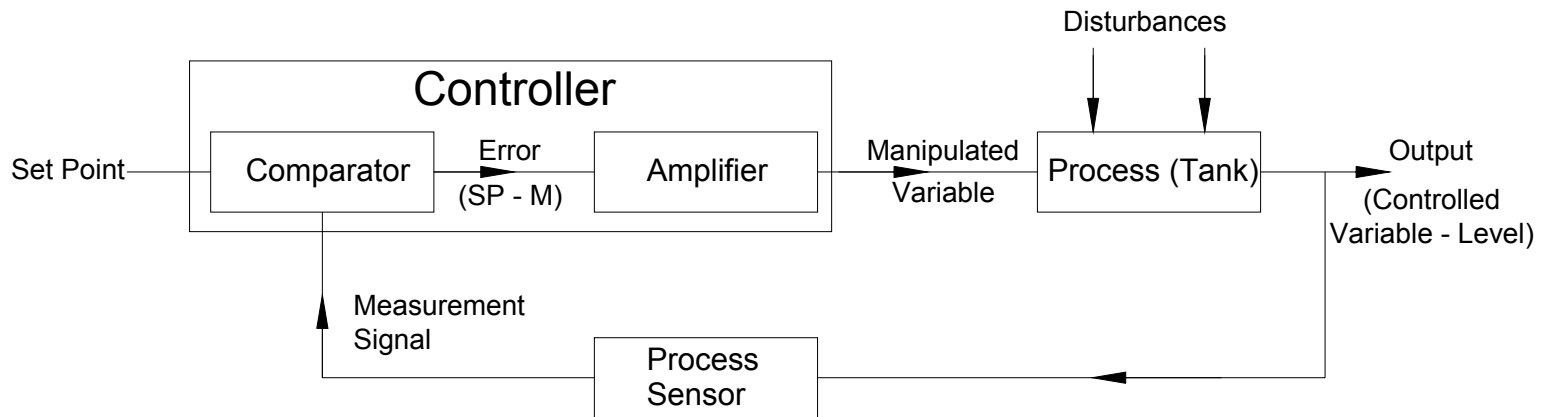

M2 Figure 1: Typical ON/OFF Control System

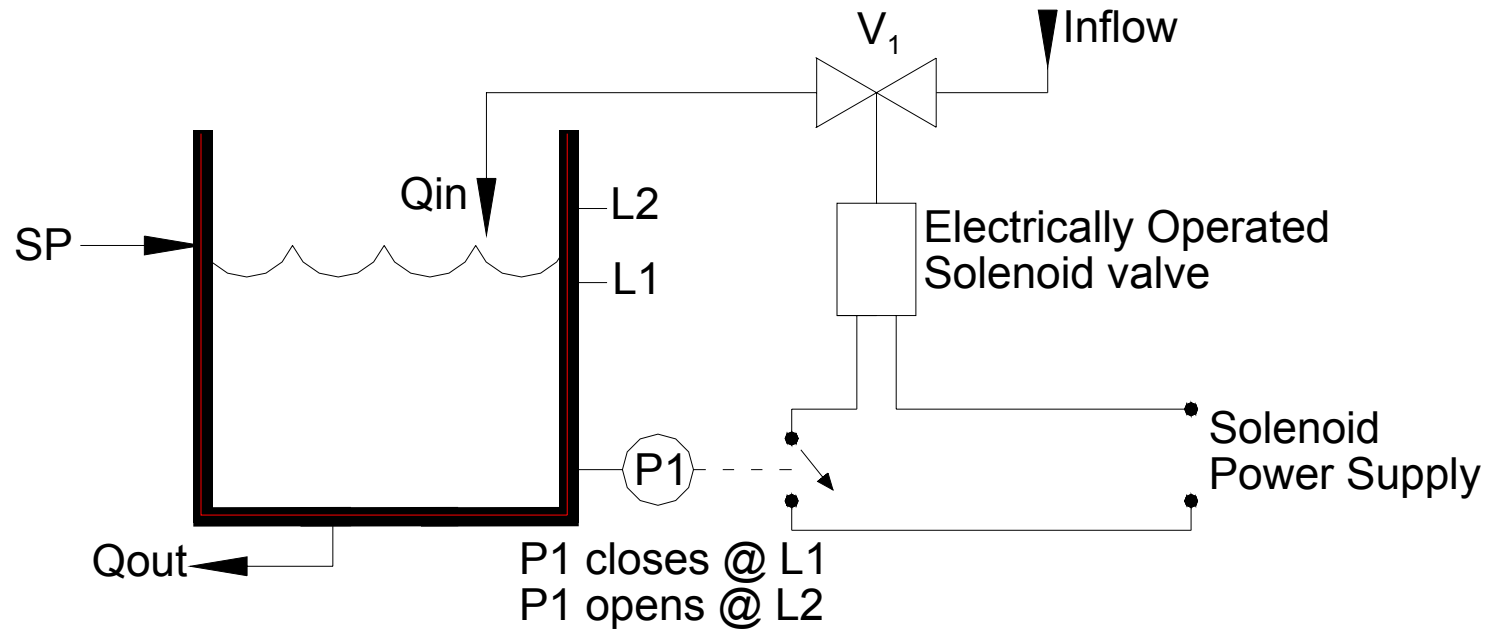

M2 Figure 2: Typical ON/OFF Response

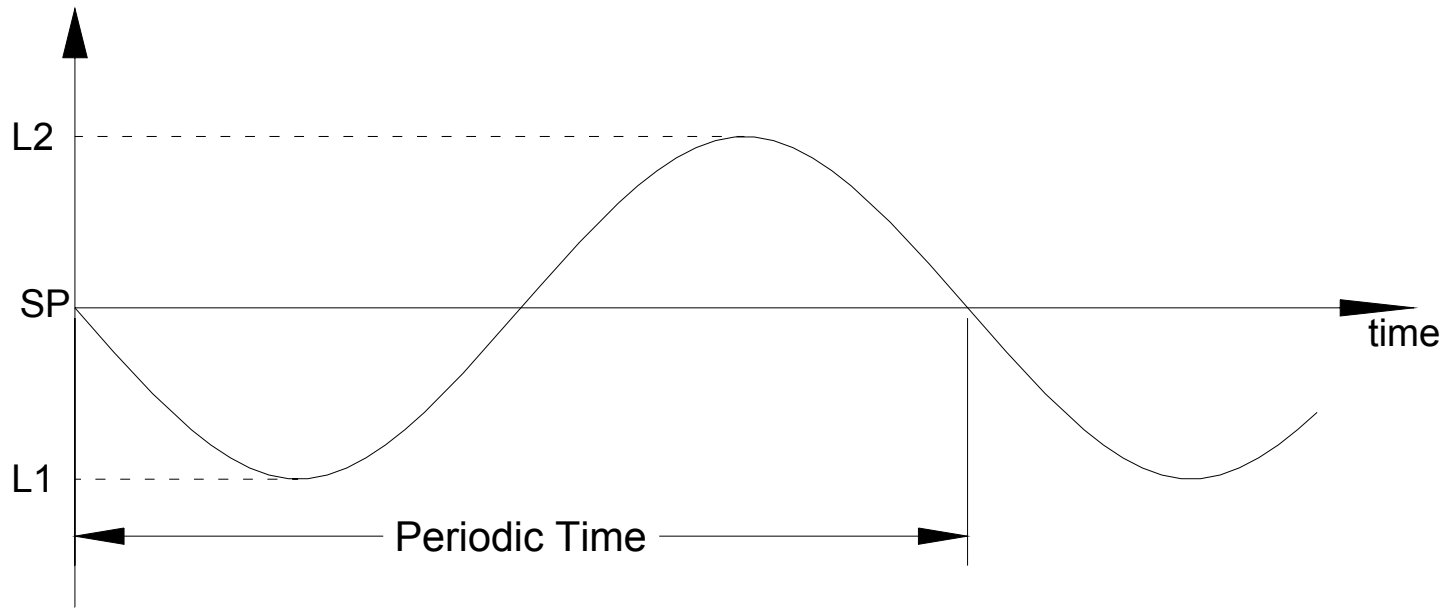

M3 Figure 1: Level Control of Open Tank

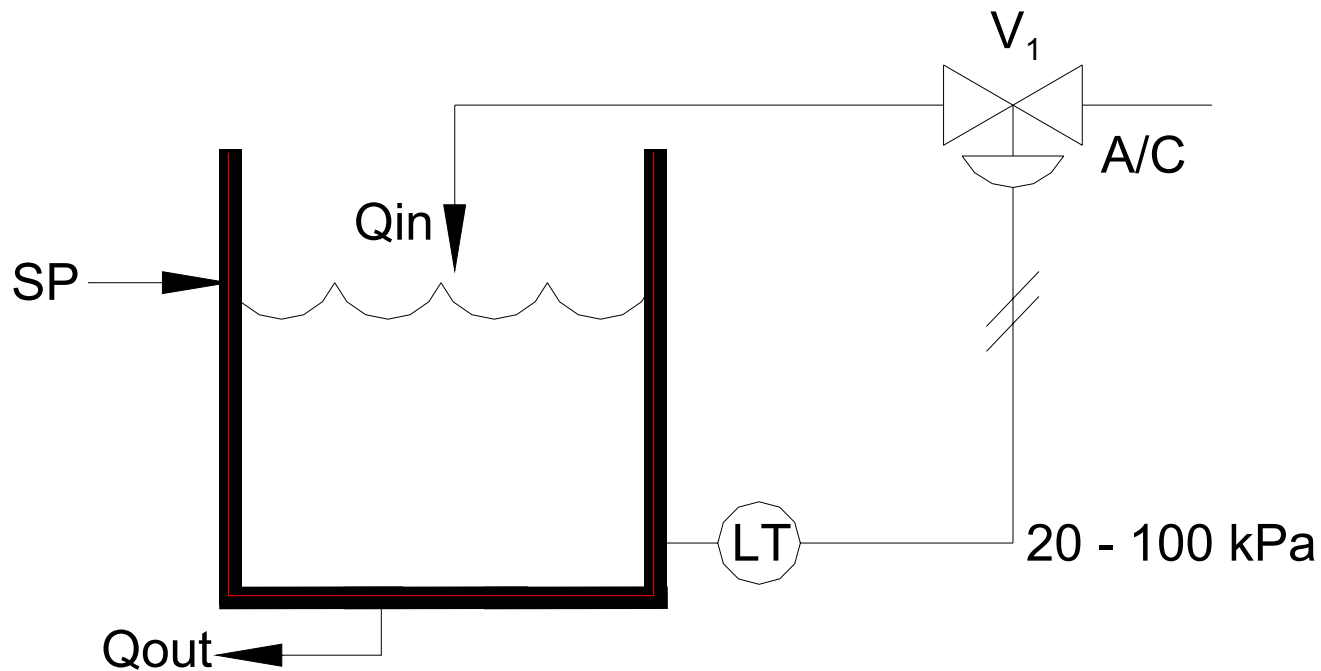

M3 Figure 2: Simple Proportional System

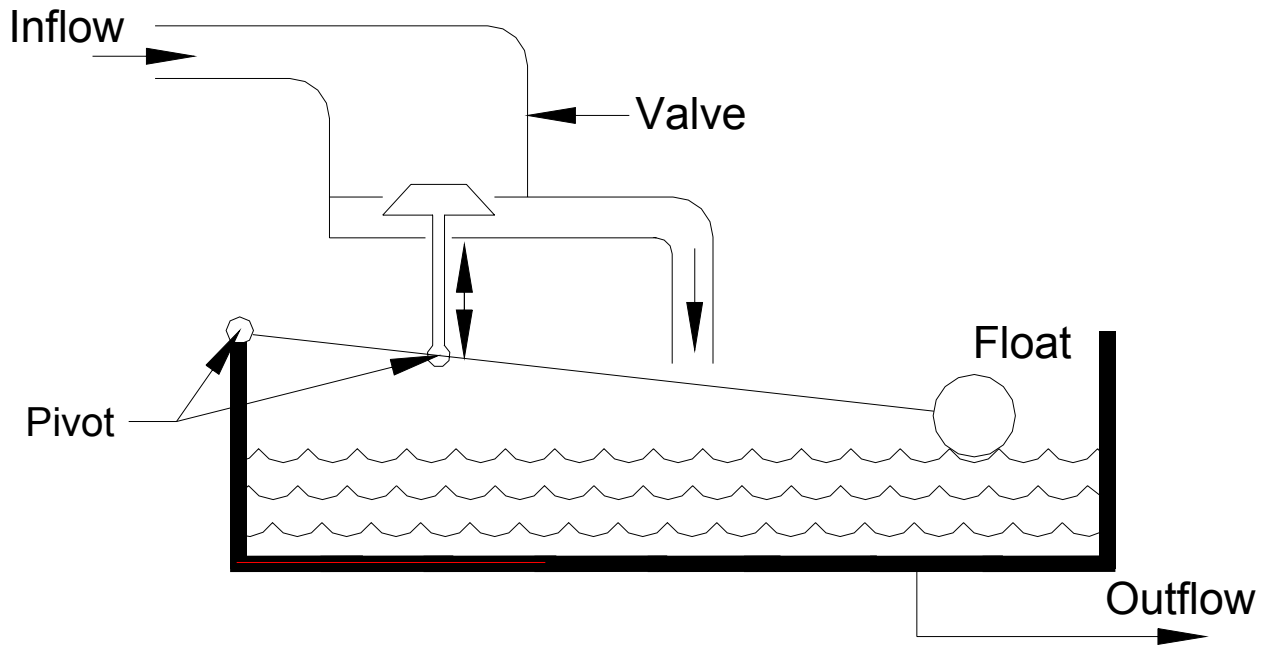

M4 Figure 1: Open Tank Control

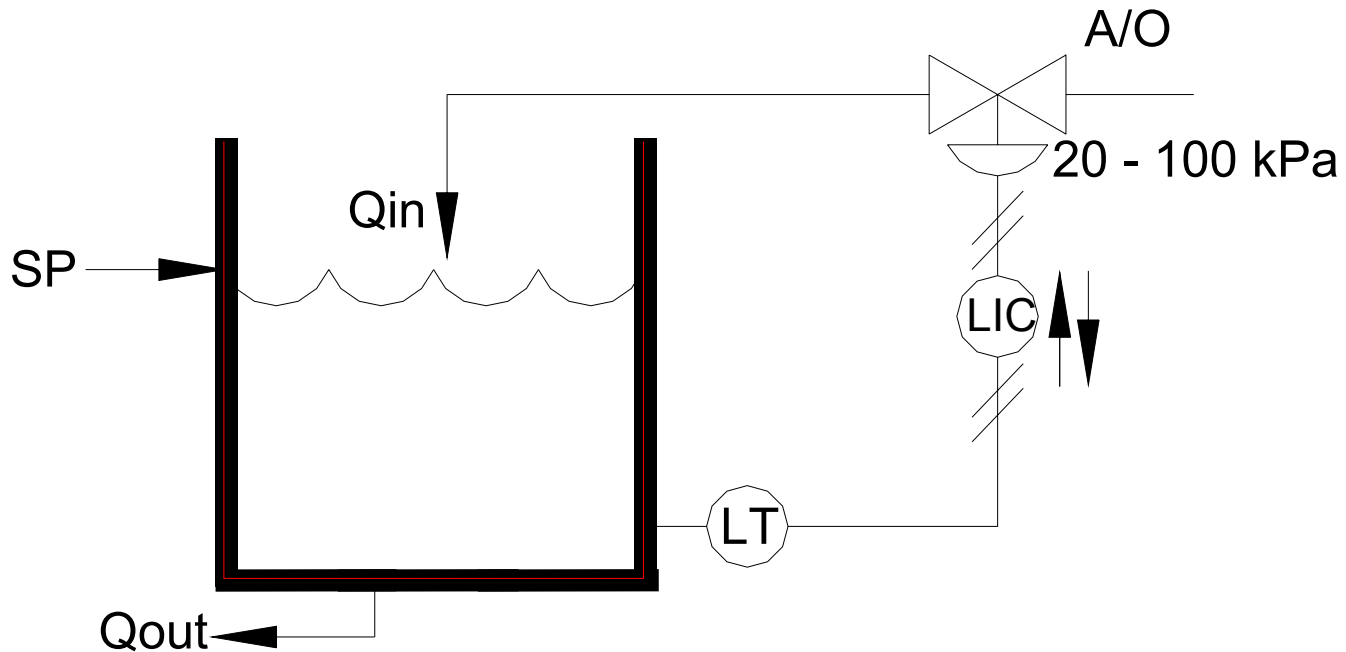

M4 Figure 2: Proportional Control Response Curve

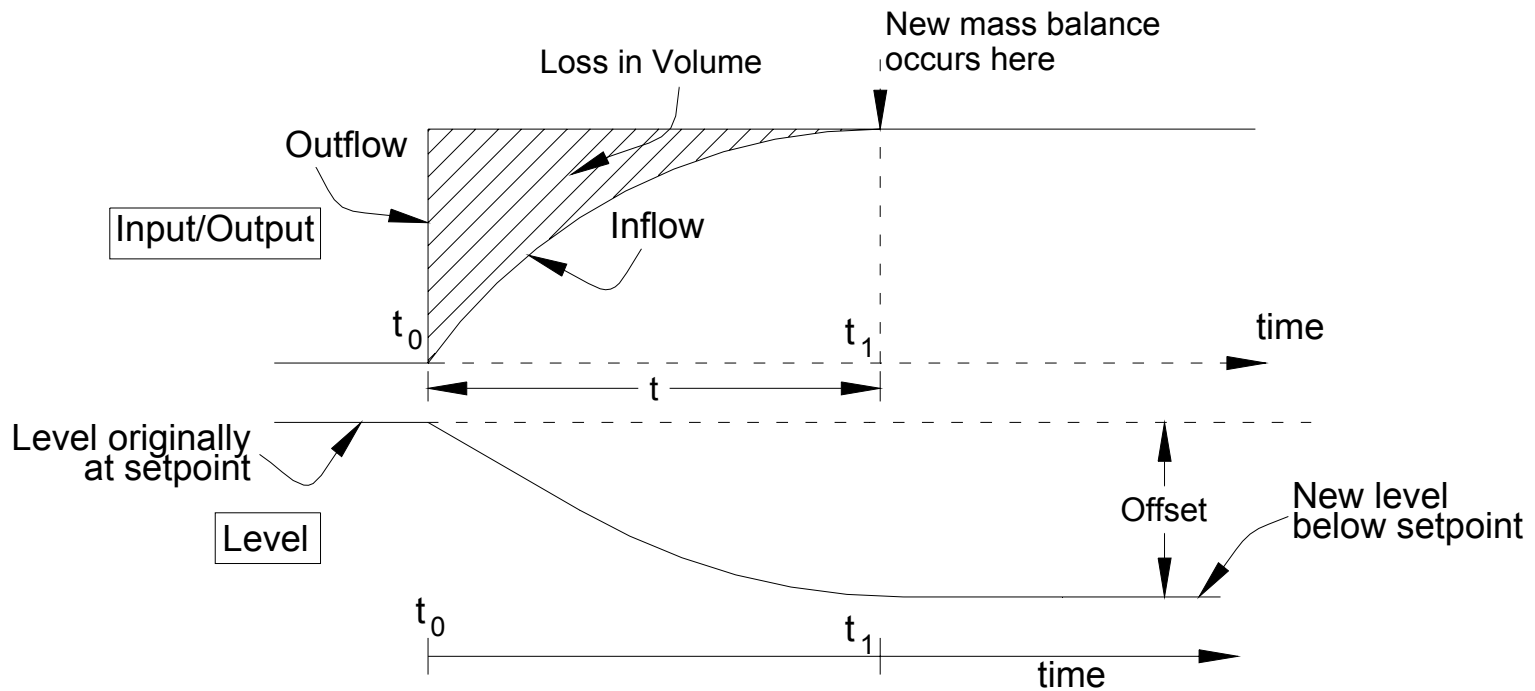

M4 Figure 3: Proportional Response with Narrower PB

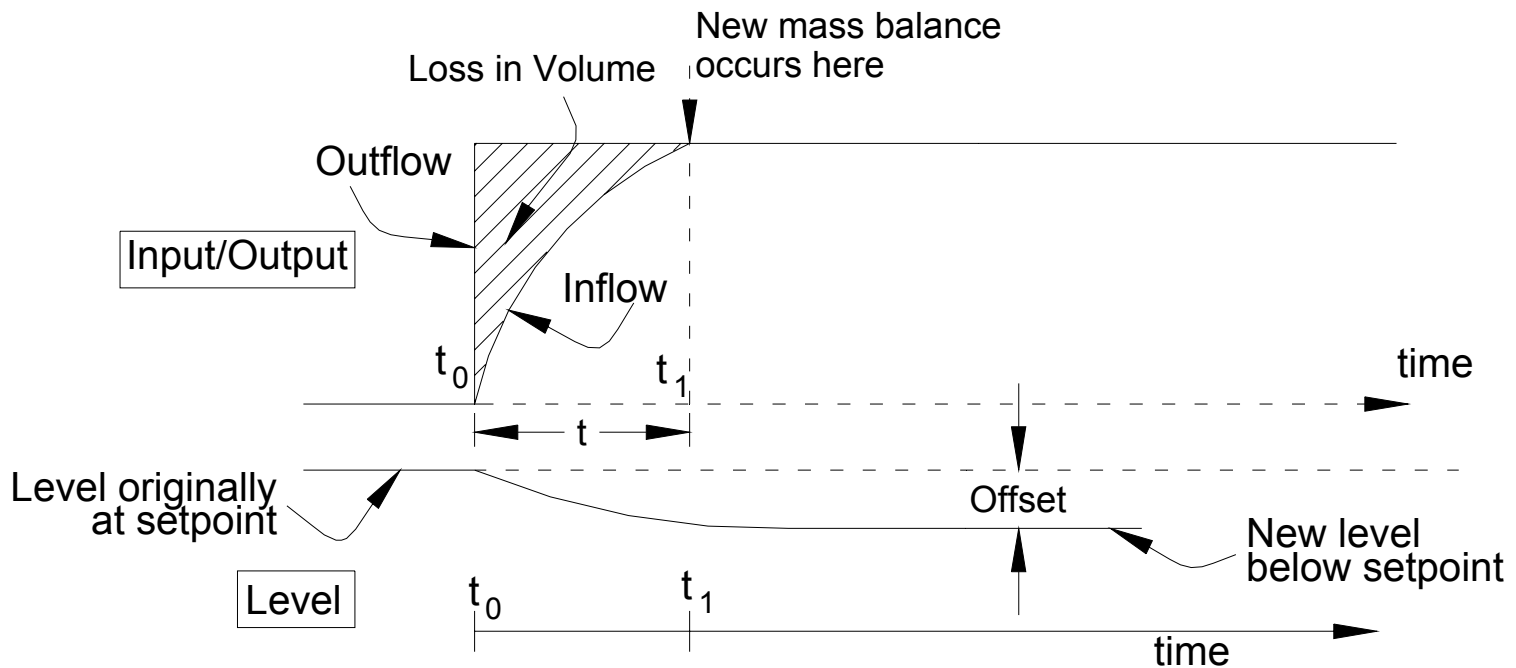

M4 Figure 4: Response Versus PB, Proportional Control Only

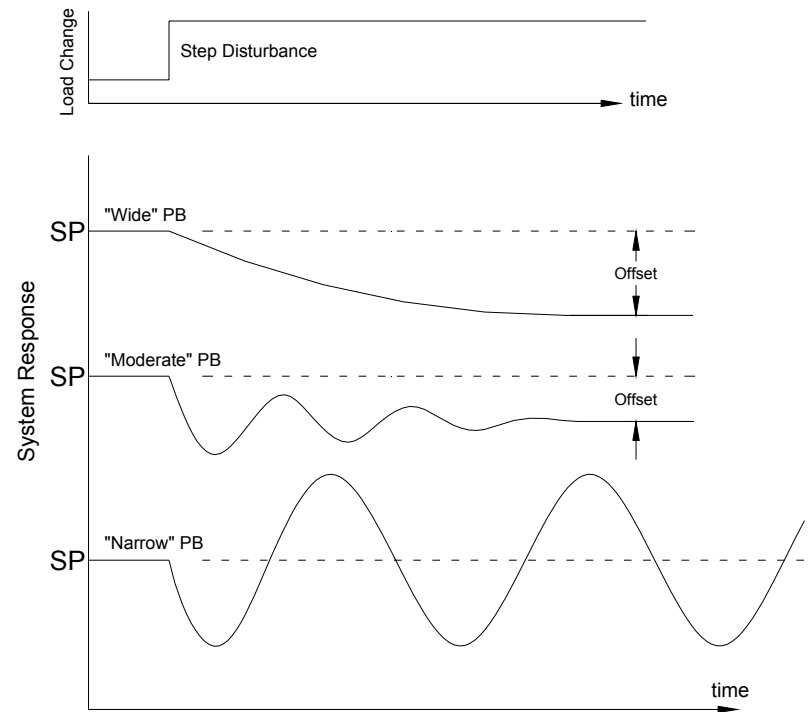

M4 Figure 5: $\frac{1}{4}$ Decay Response Curve

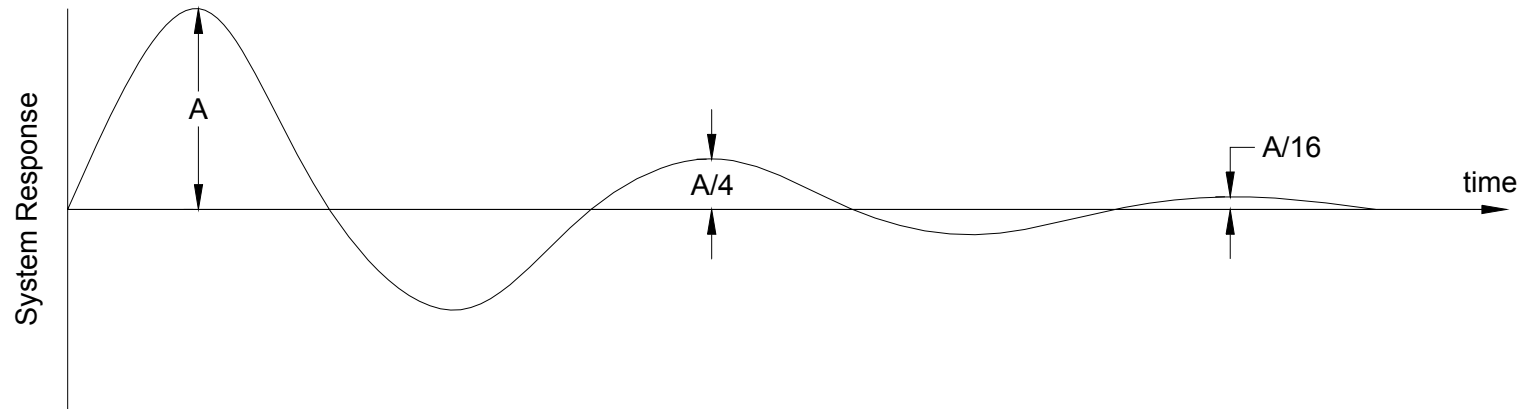

M5 Figure 1: Response Curve: Proportional Control Only

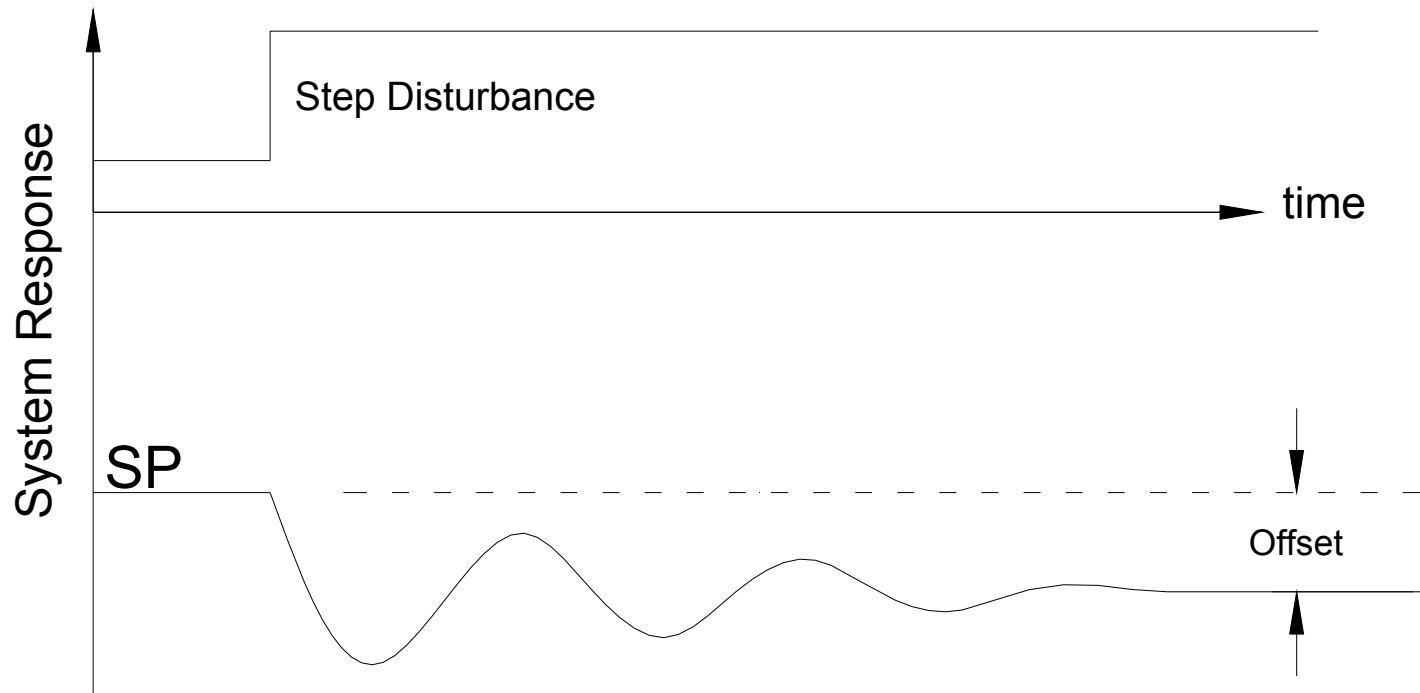

M5 Figure 2: Additional Control Signal Restores Process to Setpoint

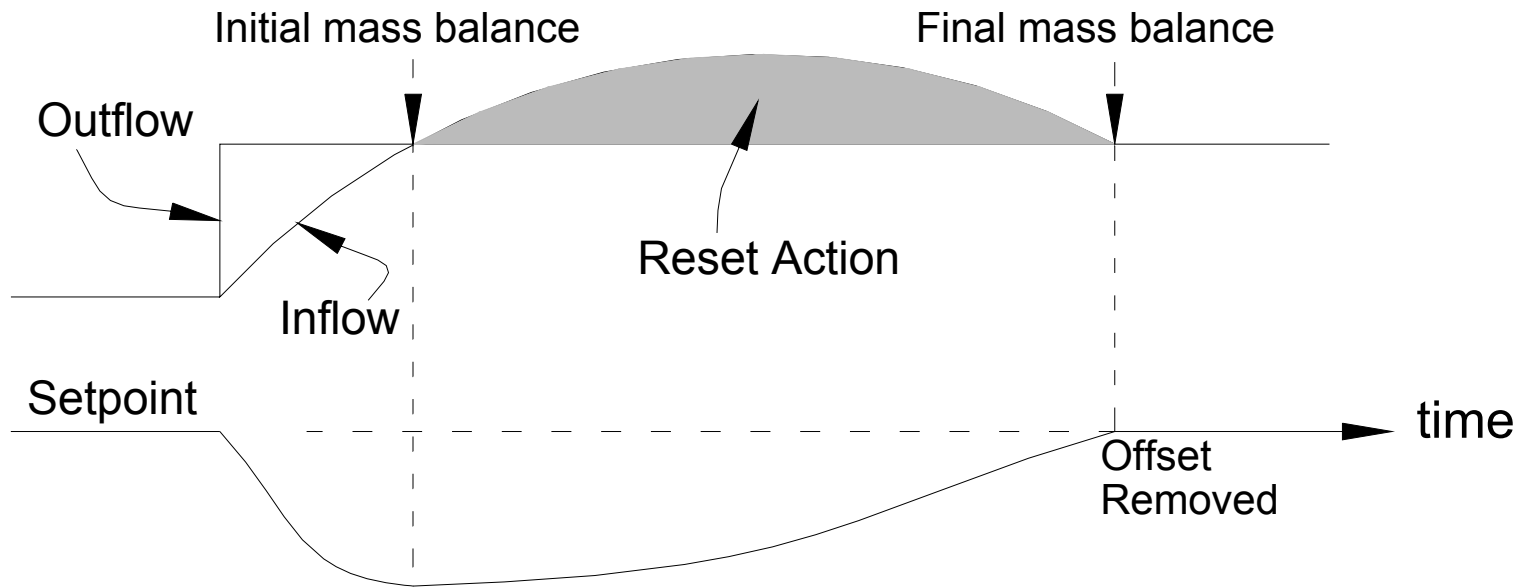

M5 Figure 3: Proportional Plus Reset, Open Loop Response

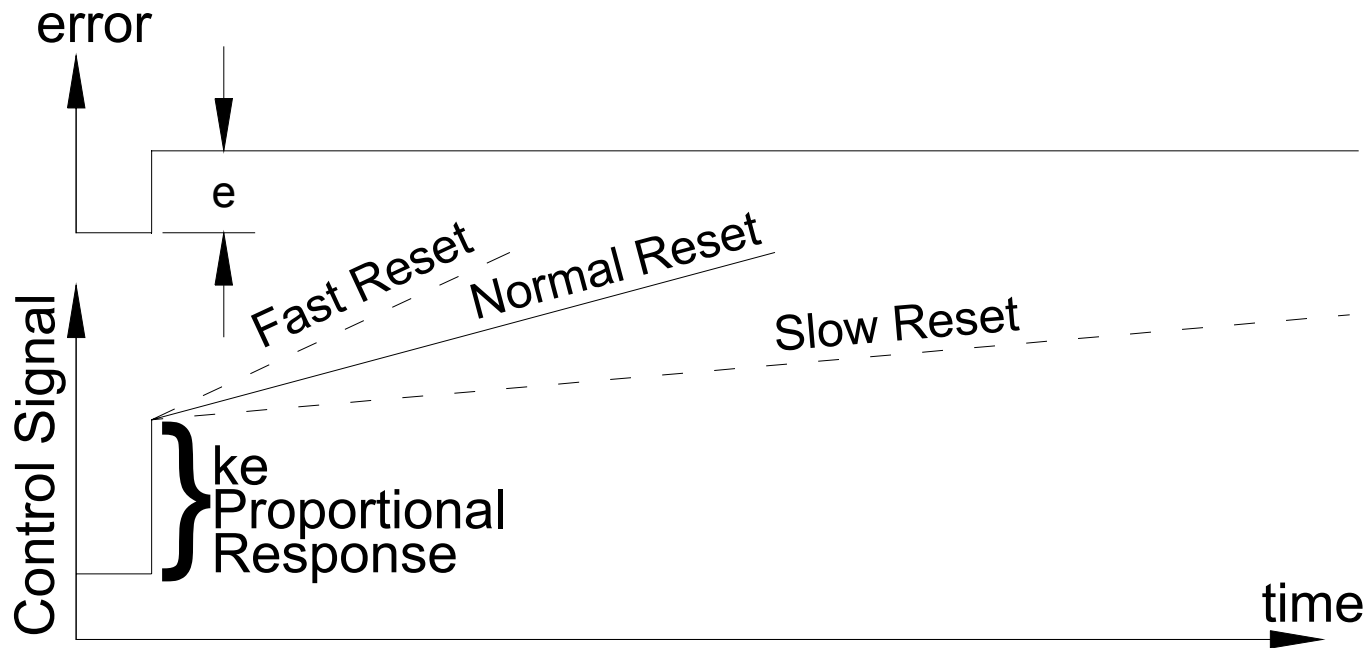

M6 Figure 1: Proportional and Derivative – Open Loop Pressure

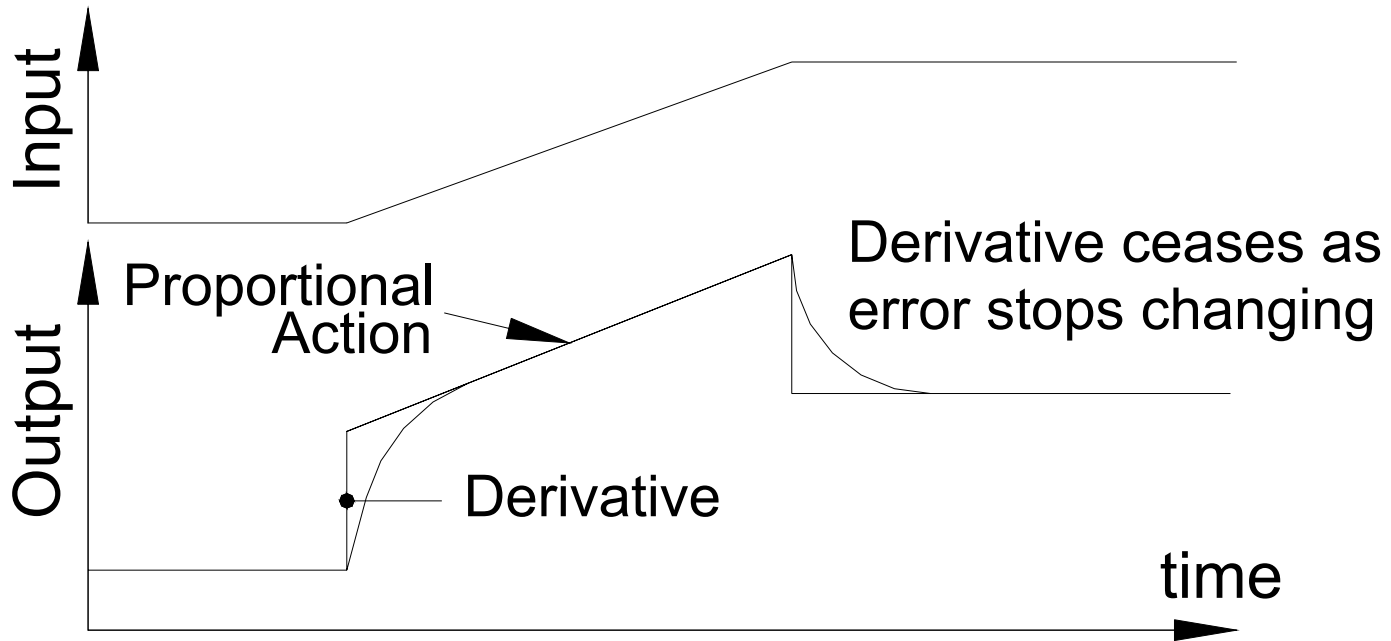

M6 Figure 2: Simple Flow Control System

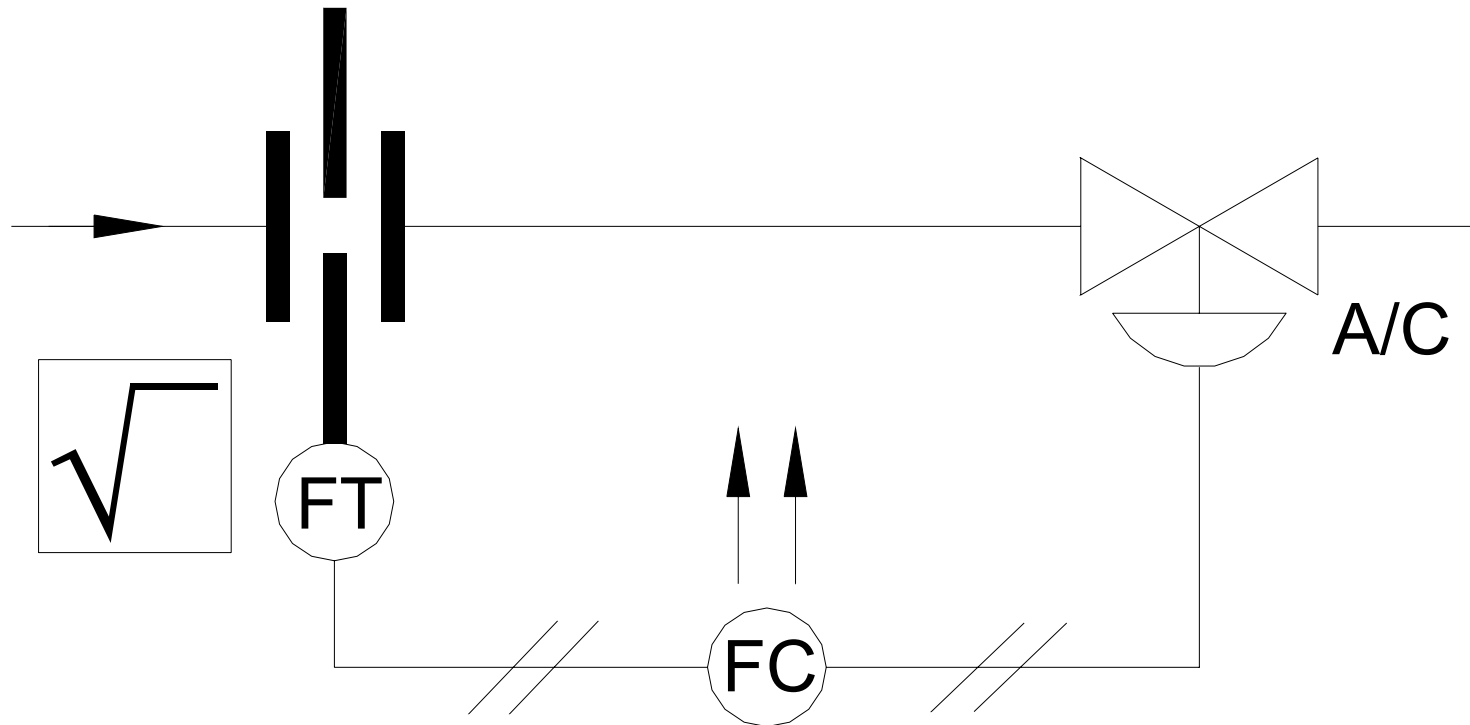

M6 Figure 3: The open Loop Response of Proportional Plus Derivative (PD) Action to Rapidly Changing Error Signals

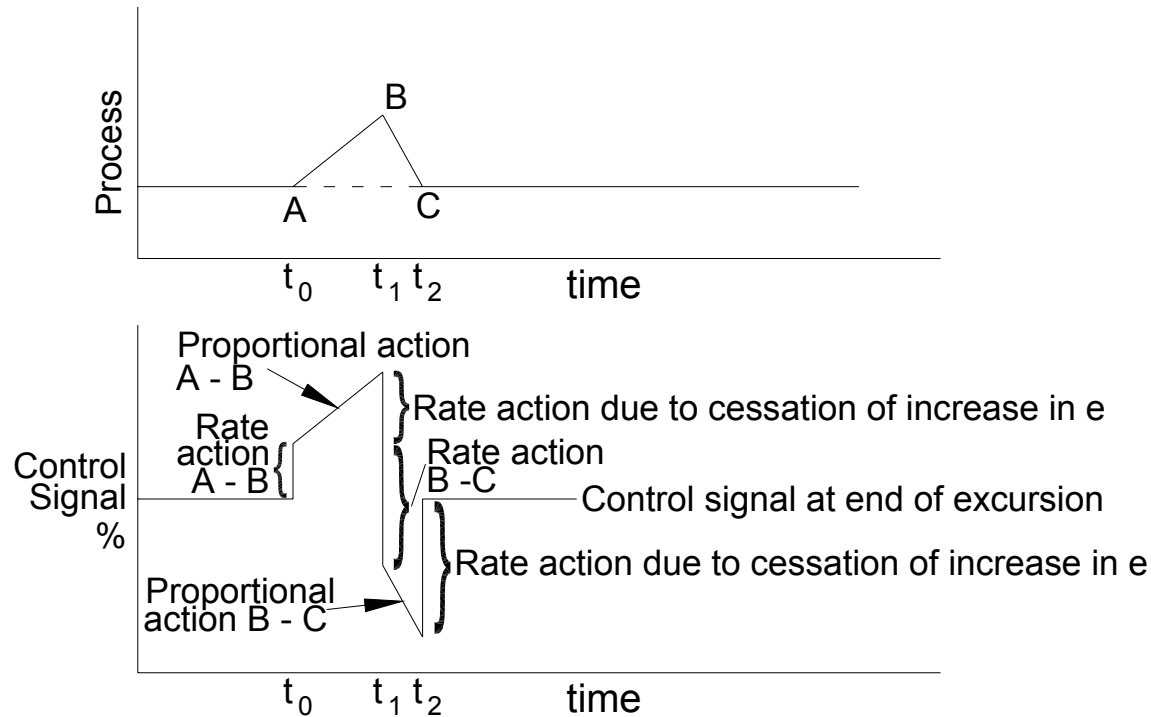

M6 Figure 4: Large System Under Proportional and Proportional Plus Derivative Control

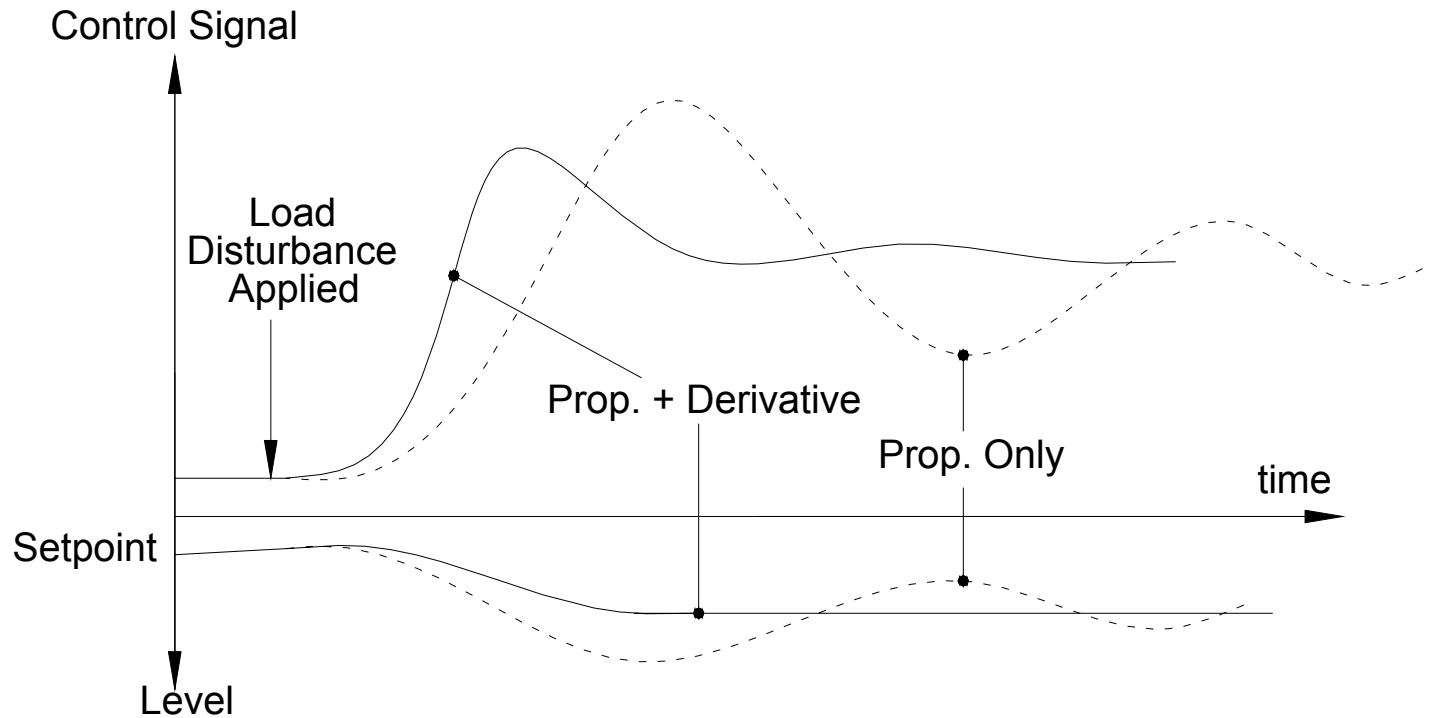

M8 Figure 1: Open Tank Level Control With Valve In Inflow

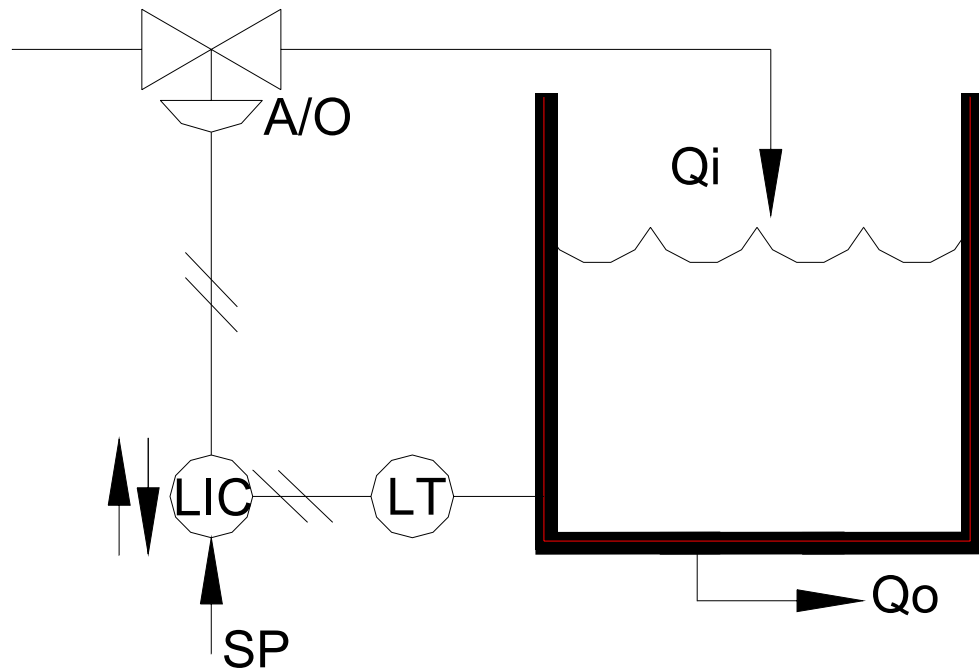

M8 Figure 2: Typical Flow Control Loop

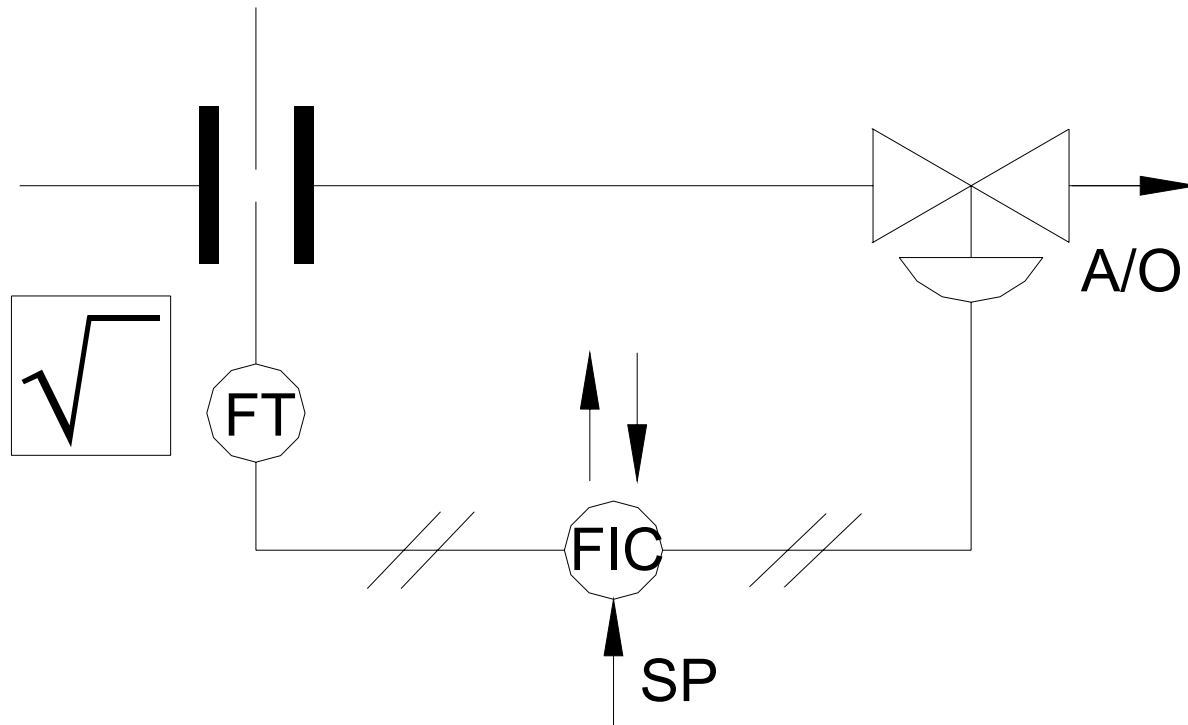

M8 Figure 3: Pressure Control – Constant Bleed

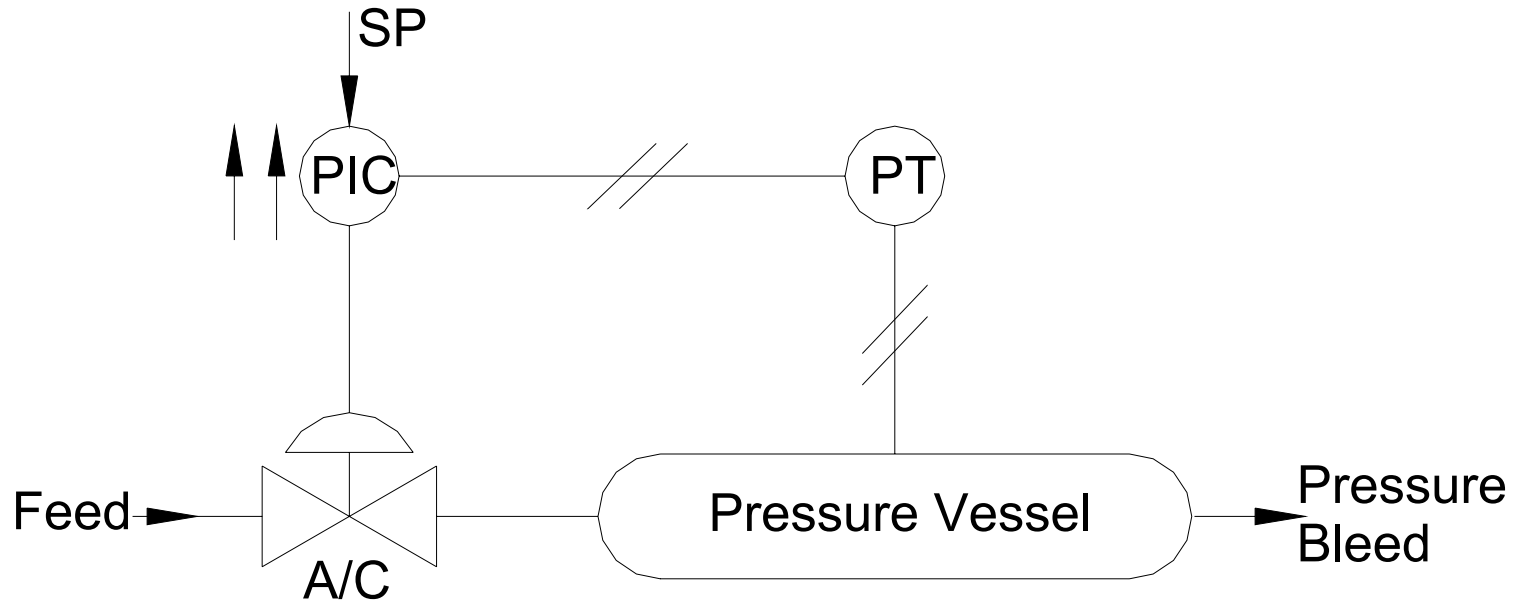

M8 Figure 4: Split Ranged Feed and Bleed Pressure Control

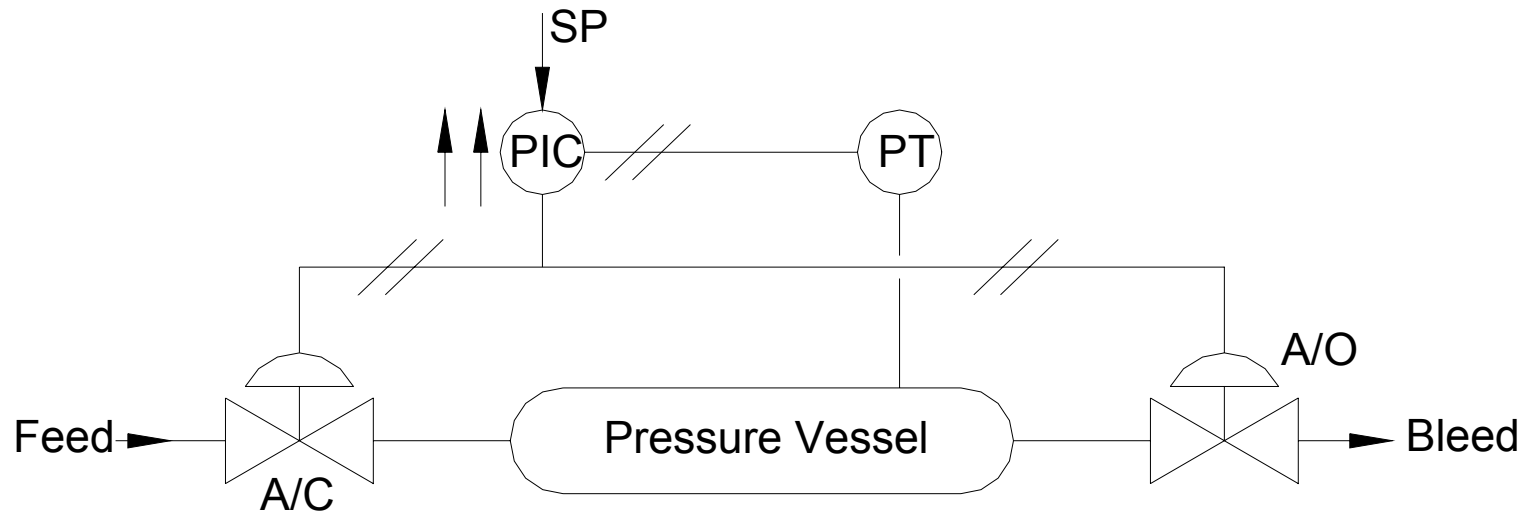

M8 Figure 5: Representative Hot Bleed/Cold Service Water Heat Exchanger

